

**TRASFORMABILI**

**satim**<sup>®</sup>  
ALUMINIUM TECHNOLOGY

 **ALFA STYL**  
výhradní zastoupení pro ČR,SK

# INDICE GENERALE

# GENERAL INDEX

## SENZA GAMBA WITHOUT LEG

---

**SIESTA**  
Tavolo da cassetto estraibile  
Pull-out drawer table **10**

---

**BRUNCH**  
Tavolo da cassetto estraibile  
Pull-out drawer table **12**

---

**COCKTAIL**  
Tavolo da cassetto estraibile  
Pull-out drawer table **14**

---

**LUNCH**  
Tavolo da cassetto estraibile  
Pull-out drawer table **16**

---

**LUNCH REVERSE**  
Tavolo da cassetto estraibile  
Pull-out drawer table **18**

---

**SHOT**  
Piano da cassetto estraibile  
Pull-out drawer worktop **20**

---

**DESK**  
Scrivania abbattibile a ribalta  
Drop-leaf foldaway desk **22**

---

**OPLÀ**  
Piano estraibile filo ripiano  
Pull-out top aligned with shelf **24**

---

**OPLÀ FOLDING**  
Piano estraibile filo ripiano  
Pull-out top aligned with shelf **26**

---

**HOMEWORK**  
Tavolo abbattibile a soffietto  
Fold-out table **28**

---

**COOK**  
Tavolo da cassetto estraibile con vano  
Pull-out drawer table with space **30**

---

**FUNCTIONAL**  
Tavolo da cassetto estraibile con vano  
Pull-out drawer table with space **32**

---

**BASKET K**  
Paniere con piano estraibile  
Pull-out bread bag with top **34**

---

**ZIP**  
Tavolo da cassetto estraibile  
con sistema sincrono:  
aperto/chiuso blocco/sblocco  
Pull-out drawer table with synchronous  
system:  
open/close lock/unlock **36**

---

**READY**  
Tavolo da cassetto estraibile con  
sistema sincrono: aperto/chiuso  
Pull-out drawer table with synchronous  
system: open/close **38**

## 1 GAMBA 1 LEG

---

**T-TABLE  
T-TABLE XL**  
Tavolo da cassetto estraibile con gamba  
singola abbattibile telescopica  
Pull-out drawer table with single  
telescopic folding leg **40**

---

**JUST**  
Piano a ribalta con gamba  
singola abbattibile telescopica  
Tilting top with single  
telescopic folding leg **42**

---

**T-BENCH  
T-BENCH XL**  
Seduta da cassetto estraibile  
con gamba singola abbattibile  
Pull-out drawer bench with  
single folding leg **44**

## 2 GAMBE 2 LEGS

---

**PARTY**  
Tavolo da cassetto estraibile con gamba  
doppia abbattibile telescopica  
Pull-out drawer table with double  
telescopic folding leg **46**

---

**EVOLUTION  
EVOLUTION XL**  
Tavolo da cabinet estraibile con gamba  
a ponte  
Pull-out cabinet table with bridge leg **50**

---

**MENSOLA PARTY**  
Tavolo da cassetto estraibile con gamba  
doppia abbattibile telescopica  
Pull-out drawer table with double  
telescopic folding leg **48**

---

**TOP**

---

**OPLÀ TOP**

Piano estraibile filo top  
Pull-out top aligned with counter top **52**

---

**SANDWICH**

Top estraibile con easybook  
Pull-out top with easybook **54**

---

**FLIP TOP**

Piano da cassetto estraibile con  
easybook  
Pull-out drawer worktop with  
easybook **56**

---

**BREAKFAST**

Piano estraibile  
Pull-out top **58**

---

**BREAKFAST TOP**

Piano scorrevole su top  
Sliding table top **60**

---

**SLIDE**

Piano scorrevole su top  
Sliding table top **62**

---

**SNACK**

Piano scorrevole  
Sliding table top **64**

---

**SNACK TOP**

Piano scorrevole su top  
Sliding table top **66**

---

**FLAP**

Piano scorrevole su top  
Sliding table top **68**

---

**CORNER**

Piano scorrevole su top  
Sliding table top **70**

---

**TWICE**

Piano scorrevole  
Sliding top **72**

---

**TWICE TOP**

Piano scorrevole su top  
Sliding table top **74**

---

**TOP33**

Piano scorrevole su top  
Sliding table top **76**

---

**PENISOLA  
PENINSULA**

---

**VOILÀ  
VOILÀ FLAG**

Piano estraibile con gambe  
Pull-out top table with legs **78**

---

**VOILÀ CHAIR**

Piano estraibile con gambe  
Pull-out top table with legs **80**

---

**VOILÀ CHAIR REVERSE**

Piano estraibile con gambe  
Pull-out top table with legs **82**

---

**DINAMICO  
DINAMICO+**

Piano scorrevole  
Sliding table top **84**

---

**SESTANTE**

Piano scorrevole e girevole  
su top con gambe  
Sliding and revolving  
table top with legs **86**

---

**+39**

---

**EVOLUTION +39  
EVOLUTION XL +39**

Tavolo da cabinet estraibile  
con gamba a ponte  
Pull-out cabinet table  
with bridge leg **88**

---

**HOMEWORK +39**

Tavolo abbattibile a soffietto  
Fold-out table **90**

---

**LUNCH +39**

Tavolo da cassetto estraibile  
Pull-out drawer table **92**

---

**MENSOLA T-ABLE +39**

Tavolo da cassetto estraibile con gamba  
singola abbattibile telescopica  
Pull-out drawer table with single  
telescopic folding leg **94**

---

**OPLÀ +39**

Piano estraibile filo ripiano  
Pull-out top flush with shelf **96**

---

**OPLÀ FOLDING +39**

Piano estraibile filo ripiano  
Pull-out top flush with shelf **98**

---

**T-BENCH +39**

Seduta da cassetto estraibile  
con gamba singola abbattibile  
Pull-out bench with single  
folding leg **100**

---

**SHOT +39**

Piano da cassetto estraibile  
Pull-out drawer worktop **102**

---

**BAGNO  
BATHROOM**

---

**PRUA  
PRUA SHORT**

Asse da stiro estraibile  
Pull-out ironing board **104**

---

**PRUA LIFT**

Asse da stiro a ribalta  
Tilting ironing board **106**

---

**PRUA SWING**

Asse da stiro rotante  
Revolving pull-out ironing board **108**

---

**BASKET**

Sacco lavanderia  
con piano estraibile  
Pull-out laundry bag with top **110**

# OPTIONAL

## 2.8016912.06

Cerniera spessori  
Hinge thickness  
16/22 mm

Da ordinare nel numero necessario al prodotto  
To be ordered in the number necessary for the product



## 2.8029912.12

Cerniera spessori  
Hinge thickness  
16/22 mm

Da ordinare nel numero necessario al prodotto  
To be ordered in the number necessary for the product



## 2.8048168.06

Cerniera spessori  
Hinge thickness  
18/30 mm

Da ordinare nel numero necessario al prodotto  
To be ordered in the number necessary for the product

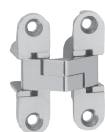

## CORNICE STICK STICK FRAME

Cornice in alluminio verniciata. Finitura: nero opaco RAL 9005  
Painted aluminum frame. Finish: matt black RAL 9005



## PIANO BIANCO WHITE TOP

Piano truciolare melaminico bianco con bordato ABS 10/10  
Codice di riferimento nella pagina del prodotto. I piani, se necessario, sono forniti di cerniere e viti  
Top white chipboard with ABS  
Reference code on the product page. The tops, if necessary, are supplied with hinges and screw

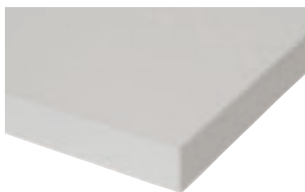

## PIANO INOX INOX TOP

Piano multistrato rivestito in acciaio AISI A430  
Codice di riferimento nella pagina del prodotto  
Plywood top covered in AISI A430 steel  
Reference code on the product page

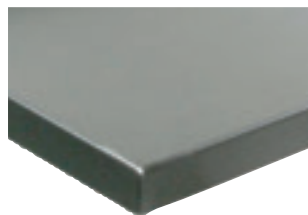

## TAPPI STICK STICK CAPS

Tappi in ABS grigio per frontale profilo.  
Codice di riferimento nella pagina del prodotto  
Gray ABS caps for front profile.  
Reference code on the product page

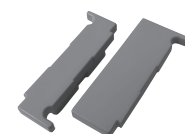

## COVER DESK

Tappi in ABS per copertura meccanismo  
Codice di riferimento nella pagina del prodotto  
ABS caps for mechanical coverage  
Reference code on the product page



## PERSONALIZZAZIONI

Tutta la serie dei nostri Trasformabili è personalizzabile in funzione delle esigenze del cliente. Dimensioni, forature, aperture, packaging e gestione, sono alcuni degli aspetti che rendono i nostri prodotti compatibili e complementari con i vostri mobili al 100%.

## PERSONALIZATION

All our Trasformabili series is customizable, depending on our clients' needs. Dimensions, drilling, opening and packaging are only some of the aspects that make our products 100% compatible and complementary to your furniture.

## SERIE SILENT

In una continua ricerca di soluzioni e migliorie, il nostro reparto R&S ha studiato ed industrializzato, per tutta la famiglia dei Trasformabili, la versione SILENT. Soluzione che conferisce ai nostri sistemi una silenziosità assoluta. Disponibile su richiesta.

## SILENT SERIES

In a constant search for improvements, our R&D department has studied and industrialized the Silent Series for all the Trasformabili collection. The solution guarantees a substantial noise reduction in all systems. Available on request.

# ATIM ONLINE

Seguici online per rimanere sempre aggiornato su tutte le nostre novità di prodotto, gli eventi, innovazioni e molto altro.

E iscriviti alla nostra **newsletter**: niente spam, solo informazioni accuratamente selezionate per te e il tuo business.

Siamo anche sui **principali canali social e portali dedicati all'architettura, all'arredamento e al design**.

Sfoggia i nostri progetti, aggiungi i nostri prodotti al tuo ideabook e interagisci direttamente con noi!

Follow us online to stay up to date on all the news about our products, events, innovations and much more.

Sign up to our **newsletter**: no spam, only information carefully selected for you and your business.

We are also on the main **social media channels and portals dedicated to architecture, furniture and design**.

Discover our projects, add our products to your ideabook and interact directly with us!

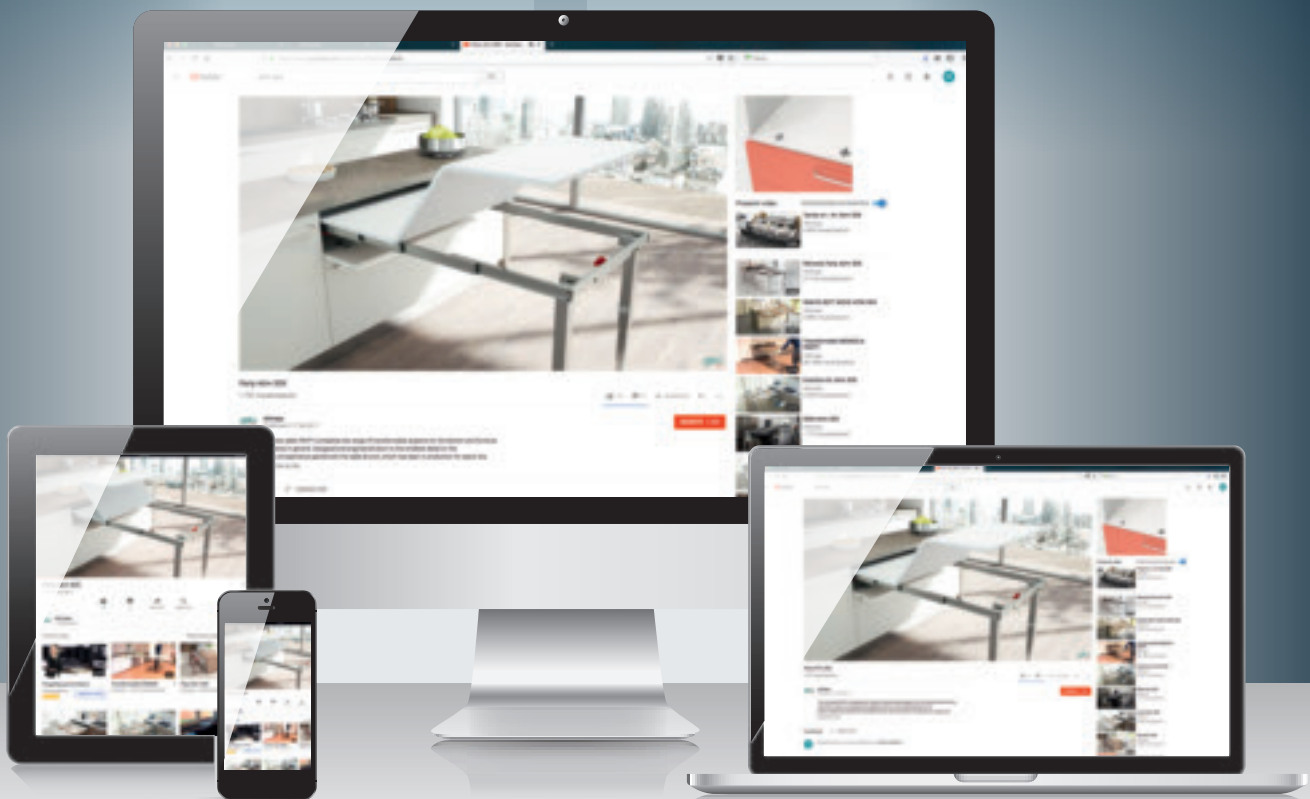

**ATTRAVERSO QUESTO QR CODE  
VERRAI INDIRIZZATO AI VIDEO DEI  
NOSTRI MECCANISMI SU YOUTUBE,  
UTILISSIMI ANCHE DURANTE IL  
MONTAGGIO.**



**USE THIS QR CODE TO WATCH  
THE TUTORIAL VIDEOS OF OUR  
MECHANISMS ON YOUTUBE,  
TO HELP YOU ALSO DURING  
THEIR ASSEMBLY.**

# Siesta

TAVOLO DA CASSETTO ESTRAIBILE  
PULL-OUT DRAWER TABLE

## DESIGN

Arch. Giulio Manzoni  
ATIM R&S / ATIM R&D

### FINITURA FINISHING

Anodizzato naturale (Grigio satinato)  
Anodised aluminium (Gray satin)

### PORTATA LOAD CAPACITY

80 Kg equamente distribuiti  
80 Kg evenly distributed

### PACKAGING

118x18x8 cm  
5 Kg  
0,017 m<sup>3</sup>

### SCORRIMENTO SLIDING

Cuscinetti a sfera  
Ball-bearing slide system

### OPTIONAL

*su richiesta on request*

### KIT TAPPI KIT CAPS

2.9250551.XX

### CERNIERE HINGES

2.8016912.06

2.8029912.12

2.8048168.06



### NOTE

L'articolo non prevede la fornitura delle parti in legno.  
The item does not include the supply of wooden parts.

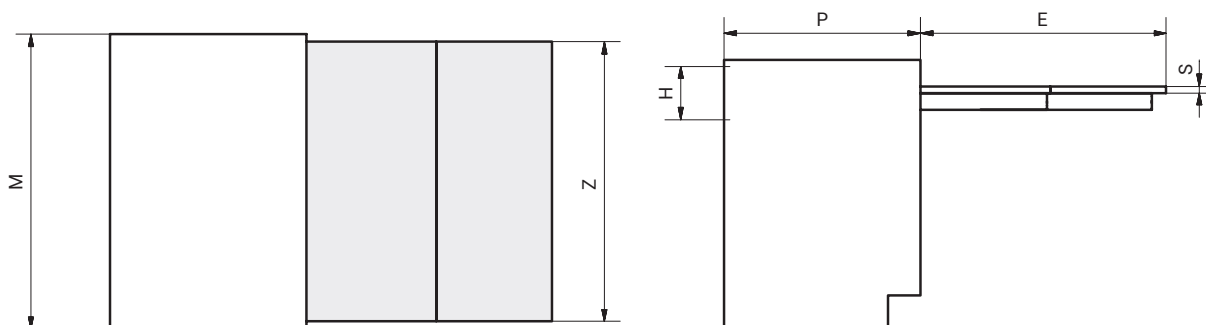

CODICE CODE	M	P MIN	H MIN.	S1	E	Z MIN	S MIN
411/78.1155.22	450	550	120	15/20	750	405	16
411/78.1150.22	600	550	120	15/20	750	555	16
411/78.1160.22	900	550	120	15/20	750	855	16
411/78.1170.22	1200	550	120	15/20	750	1155	16

Valori espressi in millimetri. Value expressed in millimetres.

Legenda tabella a pagina 112. Table key on page 112.



# Brunch

TAVOLO DA CASSETTO ESTRAIBILE  
PULL-OUT DRAWER TABLE

## DESIGN

Arch. Giulio Manzoni  
ATIM R&S / ATIM R&D

### FINITURA FINISHING

Anodizzato naturale (Grigio satinato)  
Anodised aluminium (Gray satin)

### PORTATA LOAD CAPACITY

80 Kg equamente distribuiti  
80 Kg evenly distributed

### PACKAGING

118x18x8 cm  
8,5 Kg  
0,017 m<sup>3</sup>

### SCORRIMENTO SLIDING

Cuscinetti a sfera  
Ball-bearing slide system

### OPTIONAL

*su richiesta on request*

### KIT TAPPI KIT CAPS

2.9250571.XX

### CERNIERE HINGES

2.8016912.06  
2.8029912.12  
2.8048168.06



NOTE  
L'articolo non prevede la fornitura delle parti in legno.  
The item does not include the supply of wooden parts

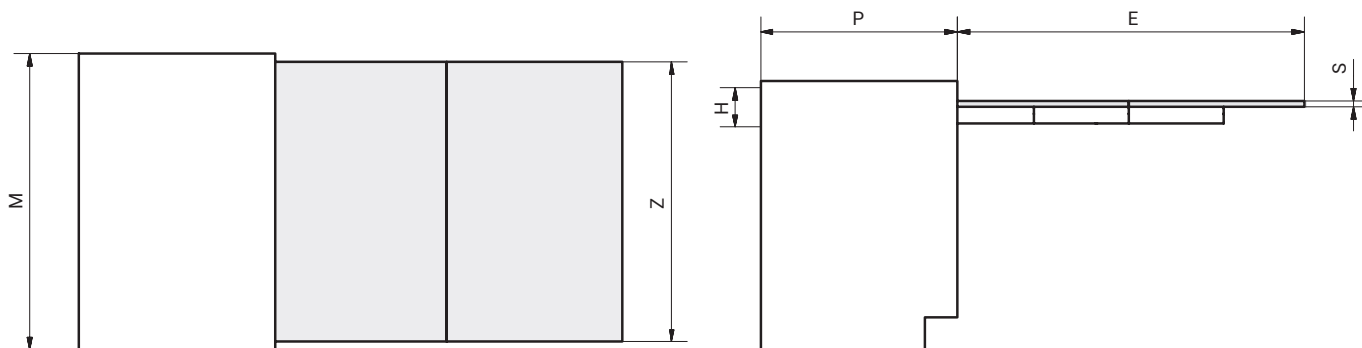

CODICE CODE	M	P MIN	H MIN.	S1	E	Z MIN	S MIN
411/78.1100.22	600	540	120	15/20	1060	555	16
411/78.1110.22	900	540	120	15/20	1060	855	16
411/78.1120.22	1200	540	120	15/20	1060	1155	16

Valori espressi in millimetri. Value expressed in millimetres.

Legenda tabella a pagina 112. Table key on page 112.





# Cocktail

TAVOLO DA CASSETTO ESTRAIBILE  
PULL-OUT DRAWER TABLE

## DESIGN

Arch. Giulio Manzoni  
ATIM R&S / ATIM R&D

### FINITURA

#### FINISHING

Inox Bronzino

### PORTATA

#### LOAD CAPACITY

60 Kg equamente distribuiti  
60 Kg evenly distributed

### PACKAGING

118x18x8 cm  
3,8 Kg  
0,017 m<sup>3</sup>

### SCORRIMENTO

#### SLIDING

Alluminio / Alluminio  
Aluminium / Aluminium

### OPTIONAL

*su richiesta on request*

### KIT TAPPI

#### KIT CAPS

2.9247221.XX

### CERNIERE

#### HINGES

2.8016912.06  
2.8029912.12  
2.8048168.06

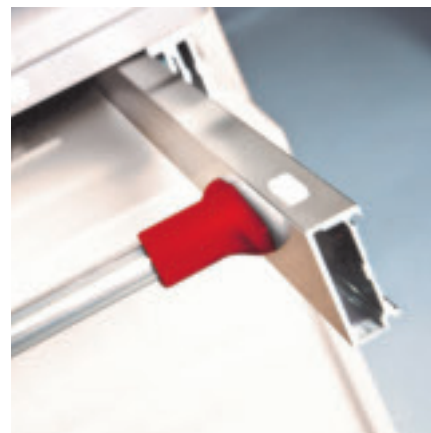

### NOTE

L'articolo non prevede la fornitura delle parti in legno.  
The item does not include the supply of wooden parts

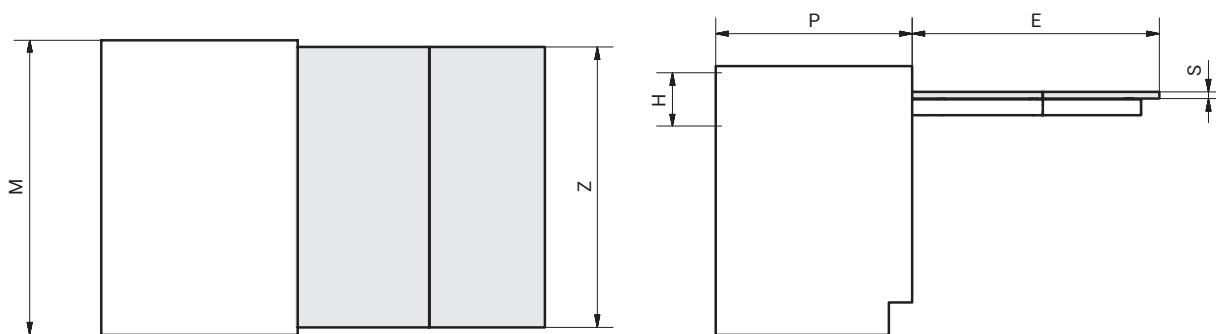

CODICE CODE	M	P MIN	H MIN.	S1	E	Z MIN	S MIN	SILENT
411/78.1155.22 E	450	540	120	15/20	753	405	16	78.1155.22 E
411/78.1150.22 E	600	540	120	15/20	753	555	16	78.1150.22 E
411/78.1160.22 E	900	540	120	15/20	753	855	16	78.1160.22 E
411/78.1170.22 E	1200	540	120	15/20	753	1155	16	78.1170.22 E

Valori espressi in millimetri. Value expressed in millimetres.

Legenda tabella a pagina 112. Table key on page 112.



# Lunch

TAVOLO DA CASSETTO ESTRAIBILE  
PULL-OUT DRAWER TABLE

## DESIGN

Arch. Giulio Manzoni  
ATIM R&S / ATIM R&D

### FINITURA

#### FINISHING

Inox Bronzino

### PORTATA

#### LOAD CAPACITY

60 Kg equamente distribuiti  
60 Kg evenly distributed

### PACKAGING

118x18x8 cm  
5 Kg  
0,017 m<sup>3</sup>

### SCORRIMENTO

#### SLIDING

Alluminio / Alluminio  
Aluminium / Aluminium

### OPTIONAL

su richiesta on request

### KIT TAPPI

#### KIT CAPS

2.9247231.XX

### PIANO

#### TOP TABLE

Truciolare bianco  
White chipboard

Lunch 450 3.9132836.12 M

Lunch 600 3.9129876.12 M

Lunch 900 3.9129866.12 M

### CERNIERE

#### HINGES

2.8016912.06

2.8029912.12

2.8048168.06

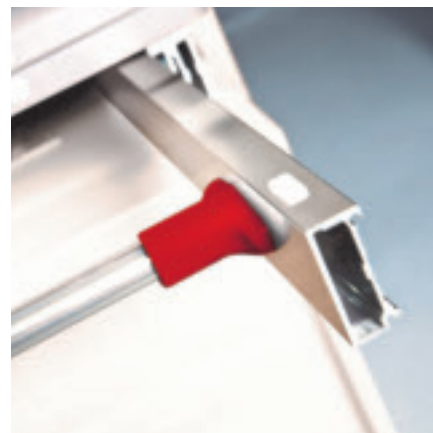

### NOTE

L'articolo non prevede la fornitura delle parti in legno.  
The item does not include the supply of wooden parts

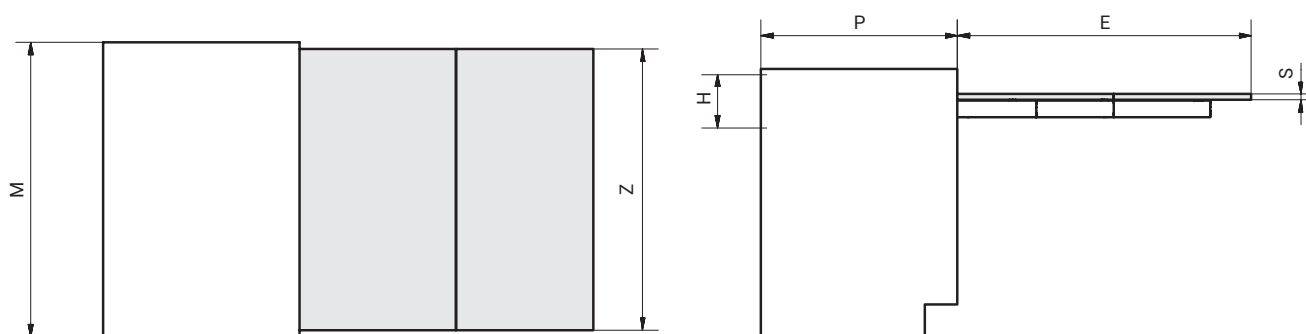

CODICE CODE	M	P MIN	H MIN	S1	E	Z MIN	S MIN	SILENT
411/78.1105.22 E	450	540	120	15/20	895	405	16	78.1105.22 E
411/78.1100.22 E	600	540	120	15/20	895	555	16	78.1100.22 E
411/78.1110.22 E	900	540	120	15/20	895	855	16	78.1110.22 E
411/78.1120.22 E	1200	540	120	15/20	895	1155	16	78.1120.22 E

Valori espressi in millimetri. Value expressed in millimetres.

Legenda tabella a pagina 112. Table key on page 112.



# Lunch Reverse

TAVOLO DA CASSETTO ESTRAIBILE  
PULL-OUT DRAWER TABLE

## DESIGN

Arch. Giulio Manzoni  
ATIM R&S / ATIM R&D

### FINITURA

#### FINISHING

Inox Bronzino

### PORTATA

#### LOAD CAPACITY

60 Kg equamente distribuiti  
60 Kg evenly distributed

### PACKAGING

118x18x8 cm  
4,5 Kg  
0,017 m<sup>3</sup>

### SCORRIMENTO

#### SLIDING

Alluminio / Alluminio  
Aluminium / Aluminium

### OPTIONAL

*su richiesta on request*

### KIT TAPPI

#### KIT CAPS

2.9247231.XX

### CERNIERE

#### HINGES

2.8016912.06  
2.8029912.12  
2.8048168.06

### NOTE

L'articolo non prevede la fornitura delle parti in legno.  
The item does not include the supply of wooden parts

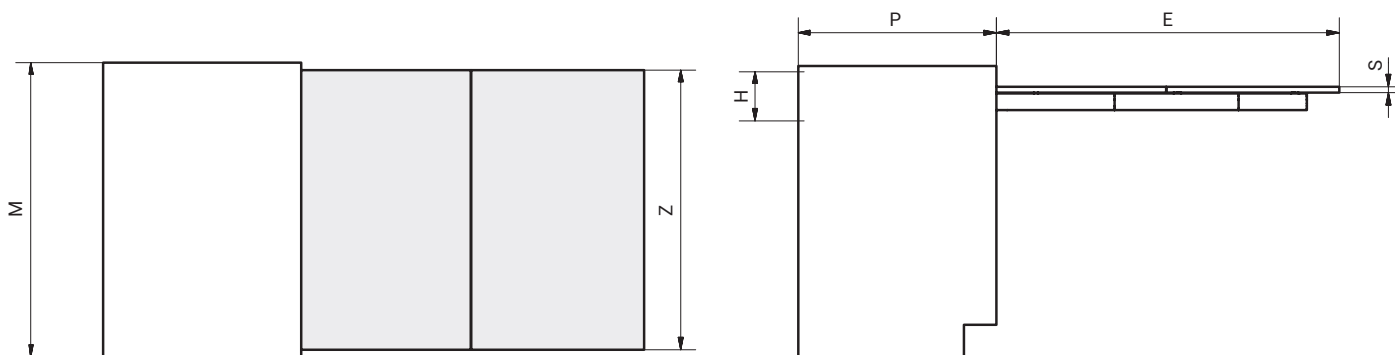

CODICE CODE	M	P MIN	H MIN	S1	E	Z MIN	S MIN	SILENT
411/78.1100.25 R	450/1200	540	120	15/20	1045	405/1155	16	78.1100.25 R

Valori espressi in millimetri. Value expressed in millimetres.

Legenda tabella a pagina 112. Table key on page 112.



# Shot

PIANO DA CASSETTO ESTRAIBILE  
PULL-OUT DRAWER WORKTOP

## DESIGN

Arch. Giulio Manzoni  
ATIM R&S / ATIM R&D

### FINITURA

#### FINISHING

Inox Bronzino

### OPTIONAL

*su richiesta on request*

### PORTATA

#### LOAD CAPACITY

80 Kg equamente distribuiti

80 Kg evenly distributed

### KIT TAPPI

#### KIT CAPS

2.9247221.XX

### PACKAGING

118x18x8 cm

4 Kg

0,017 m<sup>3</sup>

### SCORRIMENTO

#### SLIDING

Alluminio / Alluminio

Aluminium / Aluminium

### NOTE

L'articolo non prevede la fornitura delle parti in legno.  
The item does not include the supply of wooden parts

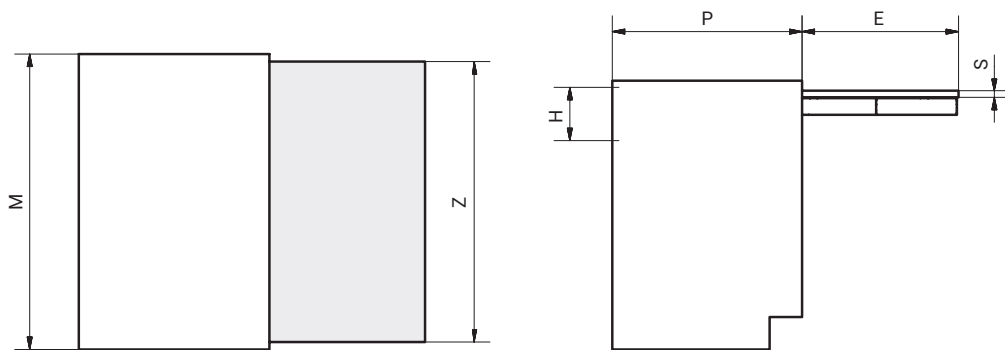

CODICE CODE	M	P MIN	H MIN	S1	E	Z	S MIN	SILENT
411/78.1130.25	450/1200	560	90	15/20	490	405/1155	16	78.1130.25
411/78.1130.25 F	450/1200	560	90	15/20	490	405/1155	16	78.1130.25 F

Valori espressi in millimetri. Value expressed in millimetres.

Legenda tabella a pagina 112. Table key on page 112.





# Desk

SCRIVANIA ABBATTIBILE A RIBALTA  
DROP-LEAF FOLDAWAY DESK

## DESIGN

Arch. Giulio Manzoni  
ATIM R&S / ATIM R&D

### FINITURA FINISHING

Ferro zincato / Galvanised iron - .02  
Acciaio inox / Stainless steel - .06

### PORTATA LOAD CAPACITY

20 Kg equamente distribuiti  
20 Kg evenly distributed

### PACKAGING

35x18x6  
3,1 Kg  
0,003 m<sup>3</sup>

### OPTIONAL

*su richiesta on request*

### COVER

Nero  
*Black*  
2.5541204.10

Bianco  
*White*  
2.5541204.12

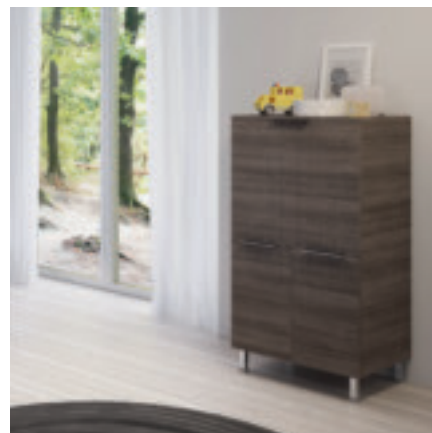

### NOTE

L'articolo non prevede la fornitura delle parti in legno.  
The item does not include the supply of wooden parts.

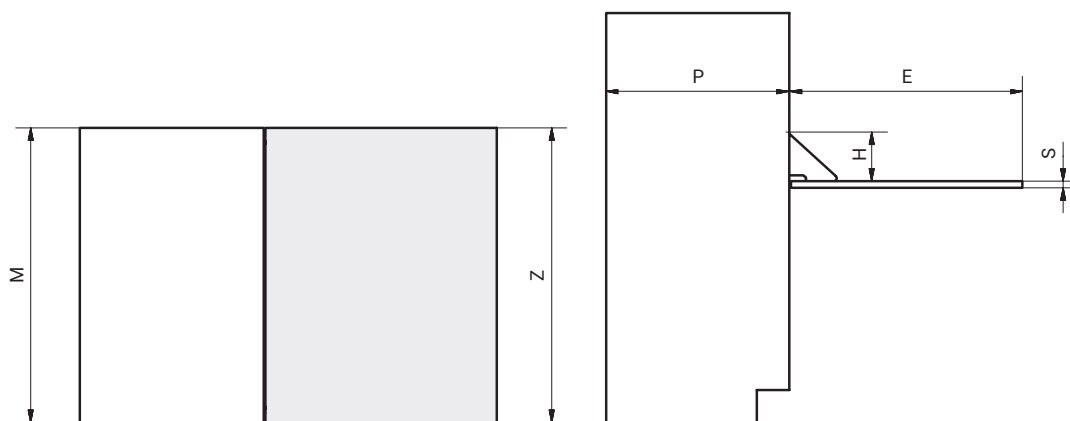

CODICE CODE	M MIN	P MIN	H MIN	S1	E MIN	Z MIN	S MIN
411/78.0005.02	450	150	200	15/20	350	445	18
411/78.0005.06	450	150	200	15/20	350	445	18

Valori espressi in millimetri. Value expressed in millimetres.

Legenda tabella a pagina 112. Table key on page 112.



# Oplà

PIANO ESTRAIBILE FILO RIPIANO  
PULL-OUT TOP ALLIGNED WITH SHELF

## DESIGN

Arch. Giulio Manzoni  
ATIM R&S / ATIM R&D

### FINITURA FINISHING

Inox Bronzino

### PORTATA LOAD CAPACITY

40 Kg equamente distribuiti  
40 Kg evenly distributed

### PACKAGING

118x18x8 cm  
4,4 Kg  
0,017 m<sup>3</sup>

### SCORRIMENTO SLIDING

Alluminio / Alluminio  
Aluminium / Aluminium

### OPTIONAL

su richiesta on request

### KIT TAPPI KIT CAPS

2.9247221.XX

### PIANO IN ACCIAIO STAINLESS TOP TABLE

Oplà 600  
411/78.1700.AC

Oplà 900  
411/78.1710.AC

Oplà 1200  
411/78.1720.AC

### PACKAGING

Oplà 600  
57x51x16 cm  
10 Kg  
0,05 m<sup>3</sup>

Oplà 900  
87x51x16 cm  
11 Kg  
0,07 m<sup>3</sup>

Oplà 1200  
117x51x16 cm  
12 Kg  
0,09 m<sup>3</sup>

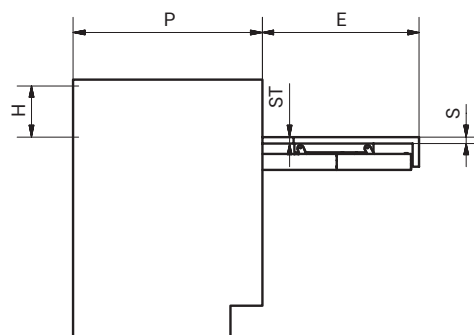
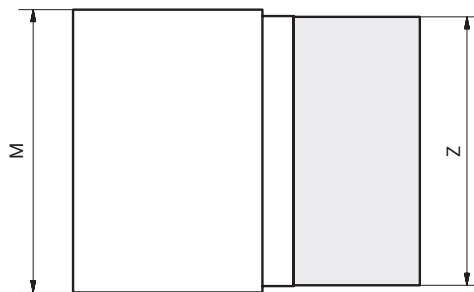

NOTE  
L'articolo non prevede la fornitura delle parti in legno.  
The item does not include the supply of wooden parts.

CODICE CODE	M	P MIN	H MIN	S1	E	Z MIN	S	ST	SILENT
411/78.1700.22	450	540	75	15/20	500	405	15/20	15/20	78.1700.22
411/78.1710.22	600	540	75	15/20	500	555	15/20	15/20	78.1710.22
411/78.1720.22	900	540	75	15/20	500	855	15/20	15/20	78.1720.22
411/78.1730.22	1200	540	75	15/20	500	1155	15/20	15/20	78.1730.22

Valori espressi in millimetri. Value expressed in millimetres.

Legenda tabella a pagina 112. Table key on page 112.



# Oplà Folding

PIANO ESTRAIBILE FILO RIPIANO  
PULL-OUT TOP ALLIGNED WITH SHELF

## DESIGN

Arch. Giulio Manzoni  
ATIM R&S / ATIM R&D

### FINITURA FINISHING

Inox Bronzino

### PORTATA LOAD CAPACITY

40 Kg equamente distribuiti  
40 Kg evenly distributed

### PACKAGING

118x18x8 cm  
7 Kg  
0,017 m<sup>3</sup>

### SCORRIMENTO SLIDING

Alluminio / Alluminio  
Aluminium / Aluminium

### OPTIONAL

su richiesta on request

### KIT TAPPI

#### KIT CAPS

2.9247221.XX



### NOTE

L'articolo non prevede la fornitura delle parti in legno.  
The item does not include the supply of wooden parts.

L'articolo è fornito solo nella versione Silent  
The item is supplied only Silent version

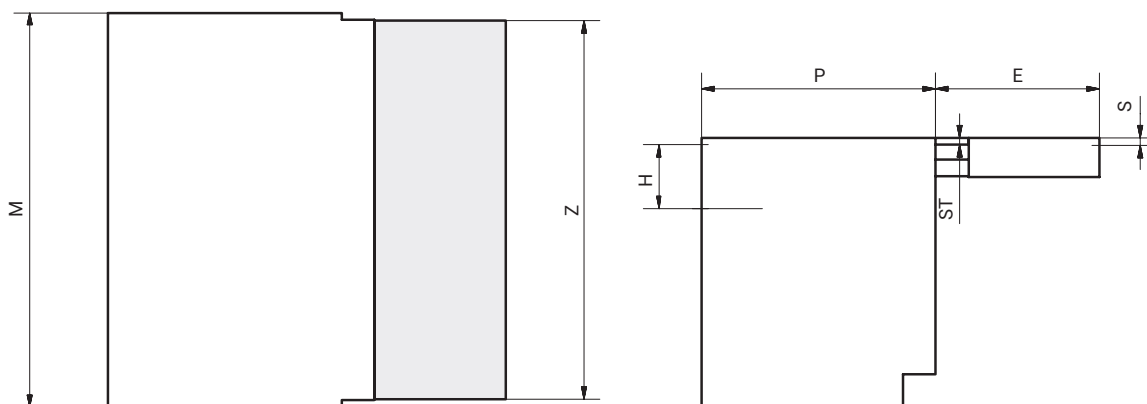

CODICE CODE	M	P MIN	H MIN	S1	E	Z MIN	S	ST
78.1700.25 F	600	540	220	18	500	555	18	15/35
78.1710.25 F	900	540	220	18	500	855	18	15/35
78.1720.25 F	1200	540	220	18	500	1155	18	15/35
78.1700.25 FS	600	540	125	18	500	550	18	15/35
78.1710.25 FS	900	540	125	18	500	850	18	15/35
78.1720.25 FS	1200	540	125	18	500	1150	18	15/35

Valori espressi in millimetri. Value expressed in millimetres.

Legenda tabella a pagina 112. Table key on page 112.



# Homework

TAVOLO ABBATTIBILE A SOFFIETTO  
FOLD-OUT TABLE

## DESIGN

Arch. Giulio Manzoni  
ATIM R&S / ATIM R&D

### FINITURA FINISHING

Inox Bronzino

### PORTATA LOAD CAPACITY

40 Kg equamente distribuiti  
40 Kg evenly distributed

### PACKAGING

118x18x8 cm  
4,5 Kg  
0,017 m<sup>3</sup>

### SCORRIMENTO SLIDING

Alluminio / Alluminio  
Aluminium / Aluminium

### OPTIONAL

*su richiesta on request*

### KIT TAPPI KIT CAPS

2.9247231.XX

### KIT HOMEWORK Cerniere + Blumotion Hinges + Blumotion

2.9248320.XX



### NOTE

L'articolo non prevede la fornitura delle parti in legno.  
The item does not include the supply of wooden parts.

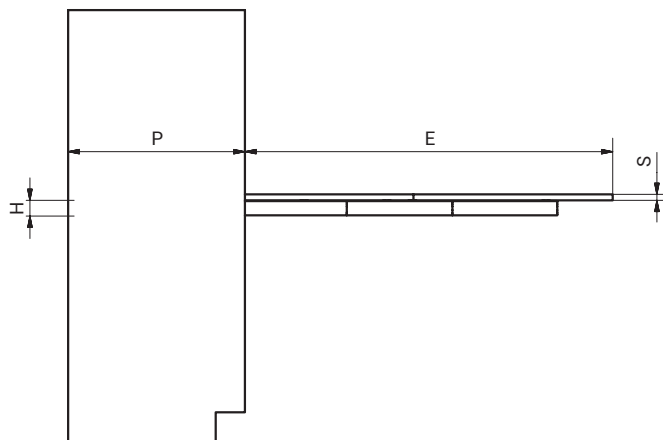
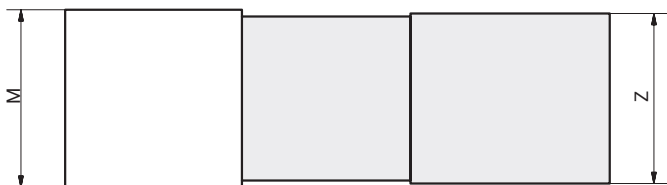

CODICE CODE	M	P MIN	H MIN	S1	E	Z MIN	S	SILENT
411/78.1200.22	600	540	54	15/20	1100	555	16	78.1200.22
411/78.1210.22	900	540	54	15/20	1100	855	16	78.1210.22
411/78.1220.22	1200	540	54	15/20	1100	1155	16	78.1220.22

Valori espressi in millimetri. Value expressed in millimetres.

Legenda tabella a pagina 112. Table key on page 112.





# Cook

TAVOLO DA CASSETTO ESTRAIBILE CON VANO  
PULL-OUT DRAWER TABLE WITH SPACE

## DESIGN

Arch. Giulio Manzoni  
ATIM R&S / ATIM R&D

### FINITURA FINISHING

Inox Bronzino

### PORTATA LOAD CAPACITY

60 Kg equamente distribuiti  
60 Kg evenly distributed

### PACKAGING

118x18x8 cm  
5 Kg  
0,017 m<sup>3</sup>

### SCORRIMENTO SLIDING

Alluminio / Alluminio  
Aluminium / Aluminium

### OPTIONAL

*su richiesta on request*

### KIT TAPPI KIT CAPS

2.9247221.XX

### CERNIERE HINGES

2.8029912.12

2.8048168.06

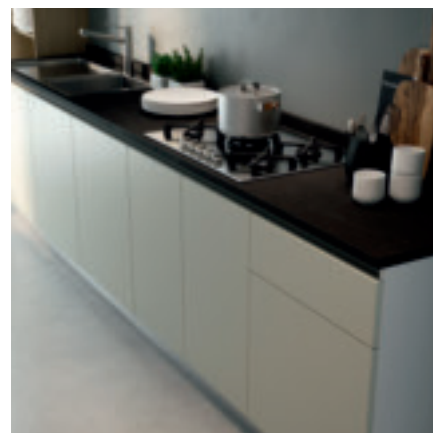

NOTE  
L'articolo non prevede la fornitura delle parti in legno.  
The item does not include the supply of wooden parts.

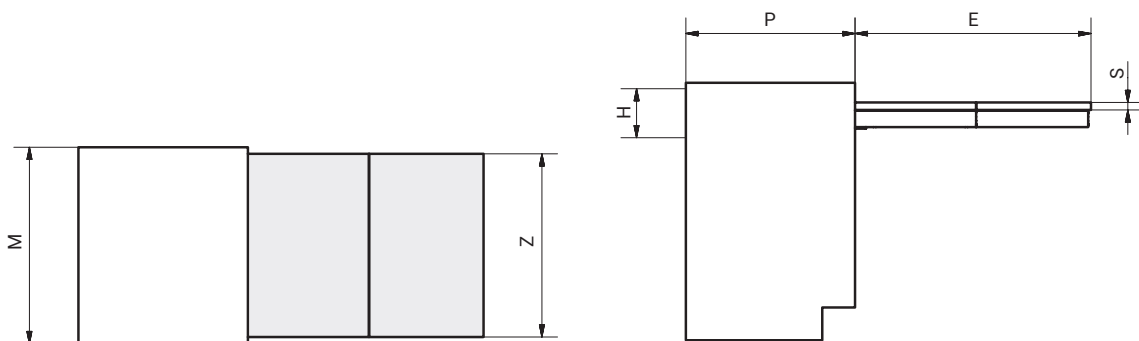

CODICE CODE	M	P MIN	H MIN	S1	E	Z	S MIN	SILENT
411/78.1490.25	600	520	120	15/20	720	555	18	78.1490.25
411/78.1491.25	900	520	120	15/20	720	855	18	78.1491.25

Valori espressi in millimetri. Value expressed in millimetres.

Legenda tabella a pagina 112. Table key on page 112.



# Functional

TAVOLO DA CASSETTO ESTRAIBILE CON VANO  
PULL-OUT DRAWER TABLE WITH SPACE

## DESIGN

Arch. Giulio Manzoni  
ATIM R&S / ATIM R&D

### FINITURA FINISHING

Inox bronzino

### PORTATA LOAD CAPACITY

40 Kg equamente distribuiti  
40 Kg evenly distributed

### PACKAGING

118x18x8 cm  
4 Kg  
0,017 m<sup>3</sup>

### SCORRIMENTO SLIDING

Alluminio / Alluminio  
Aluminium / Aluminium

### OPTIONAL

*su richiesta on request*

### KIT TAPPI

KIT CAPS  
2.9249311.XX

### CERNIERE

HINGES  
2.8016912.06  
2.8029912.12  
2.8048168.06



NOTE  
L'articolo non prevede la fornitura delle parti in legno.  
The item does not include the supply of wooden parts.

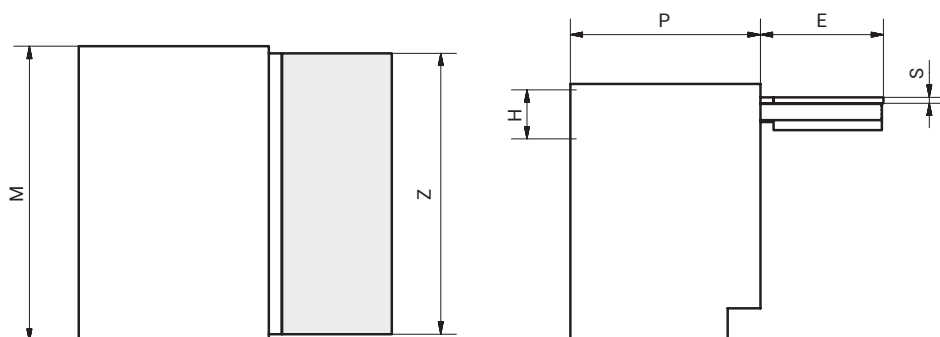

CODICE CODE	M	P MIN	H MIN	S1	E	Z MIN	S MIN	SILENT
411/78.1493.25	600	450	110	15/20	350	555	16	78.1493.25
411/78.1494.25	900	450	110	15/20	350	855	16	78.1494.25

Valori espressi in millimetri. Value expressed in millimetres.

Legenda tabella a pagina 112. Table key on page 112.



# Basket K

PANIERE CON PIANO ESTRAIBILE  
PULL-OUT BREAD BAG WITH TOP

## DESIGN

Arch. Giulio Manzoni  
ATIM R&S / ATIM R&D

### FINITURA FINISHING

Inox bronzino

### PORTATA LOAD CAPACITY

40 Kg equamente distribuiti  
40 Kg evenly distributed

### PACKAGING

118x18x8 cm  
4 Kg  
0,017 m<sup>3</sup>

### SCORRIMENTO SLIDING

Alluminio / Alluminio  
Aluminium / Aluminium

### OPTIONAL

*su richiesta on request*

### KIT TAPPI KIT CAPS

2.9249311.XX

### CERNIERE HINGES

2.8016912.06  
2.8029912.12  
2.8048168.06

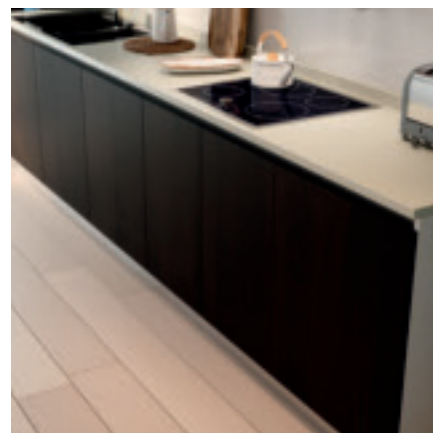

NOTE  
L'articolo non prevede la fornitura delle parti in legno.  
L'articolo è fornito con sacco in tessuto.  
The item does not include the supply of wooden parts.  
The item supplied with fabric bag.

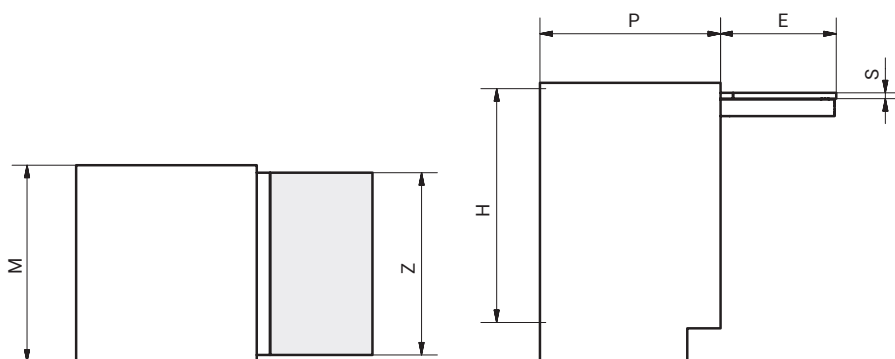

CODICE CODE	M	P MIN	H MIN	S1	E	Z	S MIN	SILENT
411/78.1497.25	450	450	690	15/20	350	405	16	78.1497.25
411/78.1498.25	600	450	690	15/20	350	555	16	78.1498.25

Valori espressi in millimetri. Value expressed in millimetres.

Legenda tabella a pagina 112. Table key on page 112.



# Zip

TAVOLO DA CASSETTO ESTRAIBILE CON  
SISTEMA SINCRONO: APERTO/CHIUSO  
BLOCCO/SBLOCCO  
PULL-OUT DRAWER TABLE WITH  
SYNCHRONOUS SYSTEM:  
OPEN/CLOSE LOCK/UNLOCK

## FINITURA FINISHING

Anodizzato naturale (Grigio satinato)  
Anodised aluminium (Gray satin)

## PORTATA LOAD CAPACITY

80 Kg equamente distribuiti  
80 Kg evenly distributed

## PACKAGING

118x18x8 cm  
5 Kg  
0,017 m<sup>3</sup>

## SCORRIMENTO SLIDING

Cuscinetti a sfera  
Ball-bearing slide system

## OPTIONAL

*su richiesta on request*

## KIT TAPPI

### KIT CAPS

2.9251951.XX

## CERNIERE

### HINGES

2.8016912.06

2.8029912.12

2.8048168.06

## DESIGN

Arch. Giulio Manzoni  
ATIM R&S / ATIM R&D



NOTE  
L'articolo non prevede la fornitura delle parti in legno.  
The item does not include the supply of wooden parts.

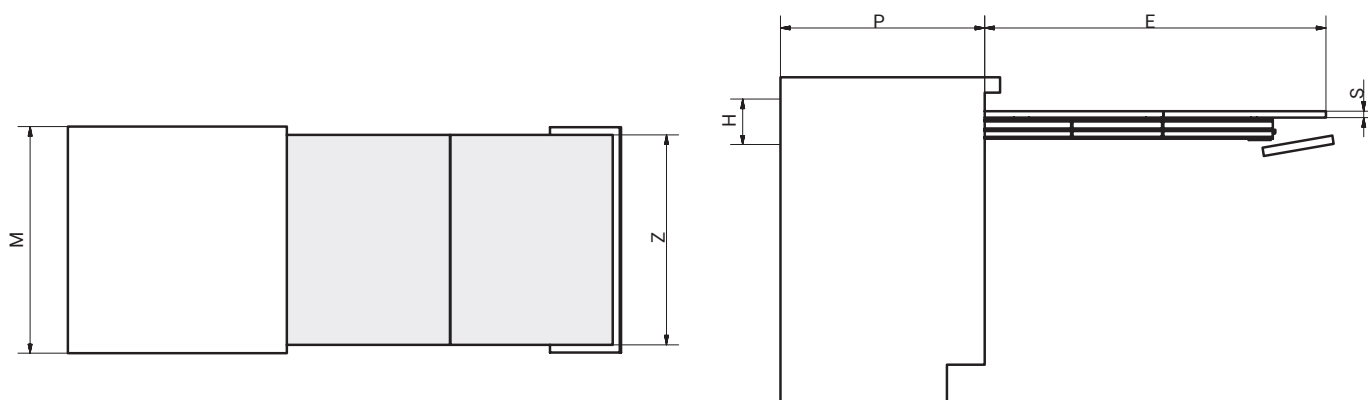

CODICE CODE	M	P MIN	H MIN	S1	E	Z MIN	S
411/78.1261.22	600	550	120	15/20	900	555	18
411/78.1262.22	900	550	120	15/20	900	855	18

Valori espressi in millimetri. Value expressed in millimetres.

Legenda tabella a pagina 112. Table key on page 112.





# Ready

TAVOLO DA CASSETTO ESTRAIBILE CON  
SISTEMA SINCRONO: APERTO/CHIUSO  
PULL-OUT DRAWER TABLE WITH  
SYNCHRONOUS SYSTEM: OPEN/CLOSE

## FINITURA FINISHING

Inox Bronzino

## PORTATA LOAD CAPACITY

60 Kg equamente distribuiti  
60 Kg evenly distributed

## PACKAGING

118x18x8 cm  
5 Kg  
0,017 m<sup>3</sup>

## SCORRIMENTO SLIDING

Alluminio / Alluminio  
Aluminium / Aluminium

## OPTIONAL

su richiesta on request

## KIT TAPPI KIT CAPS

2.9247231.XX

## PIANO TOP TABLE

Truciolare bianco  
White chipboard

Ready 600  
2.9152806.12M

Ready 900  
2.9152826.12M

## DESIGN

Arch. Giulio Manzoni  
ATIM R&S / ATIM R&D



NOTE  
L'articolo non prevede la fornitura delle parti in legno.  
The item does not include the supply of wooden parts.

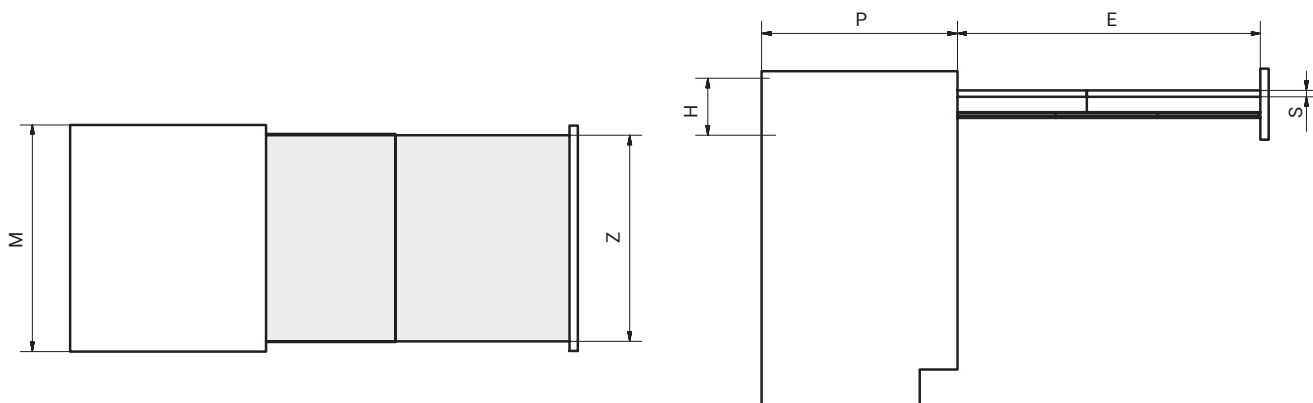

CODICE CODE	M	P MIN	H MIN	S1	E	Z MIN	S	SILENT
411/78.1141.25	600	490	150	15/20	800	540	16/18	78.1141.25
411/78.1142.25	900	490	150	15/20	800	840	16/18	78.1142.25

Valori espressi in millimetri. Value expressed in millimetres.

Legenda tabella a pagina 112. Table key on page 112.



# T-Able / T-Able XL

## DESIGN

Arch. Giulio Manzoni  
ATIM R&S / ATIM R&D

TAVOLO DA CASSETTO ESTRAIBILE  
CON GAMBA SINGOLA ABBATTIBILE TELESCOPICA  
PULL-OUT DRAWER TABLE  
WITH SINGLE TELESCOPIC FOLDING LEG

### FINITURA

#### FINISHING

Inox bronzino

### PORTATA

#### LOAD CAPACITY

100 Kg equamente distribuiti  
100 Kg evenly distributed

### PACKAGING

#### T-Able

118x18x8 cm  
7,5 Kg  
0,017 m<sup>3</sup>

#### T-Able XL

118x18x8 cm  
8 Kg  
0,017 m<sup>3</sup>

### SCORRIMENTO

#### SLIDING

Alluminio / Alluminio  
Aluminium / Aluminium

### OPTIONAL

su richiesta on request

### KIT TAPPI

#### KIT CAPS

#### T-Able

2.9247231.XX

#### T-Able XL

2.9247251.XX

### PIANO

#### TOP TABLE

Truciolare bianco  
White chipboard

#### T-Able 600

3.9129876.12 M

#### T-Able 900

3.9129866.12 M

#### T-Able XL 600

3.9155026.12 M

#### T-Able XL 900

3.9155036.12 M

### CERNIERE

#### HINGES

2.8016912.06

2.8029912.12

2.8048168.06

#### NOTE

L'articolo non prevede la fornitura delle parti in legno.  
The item does not include the supply of wooden parts

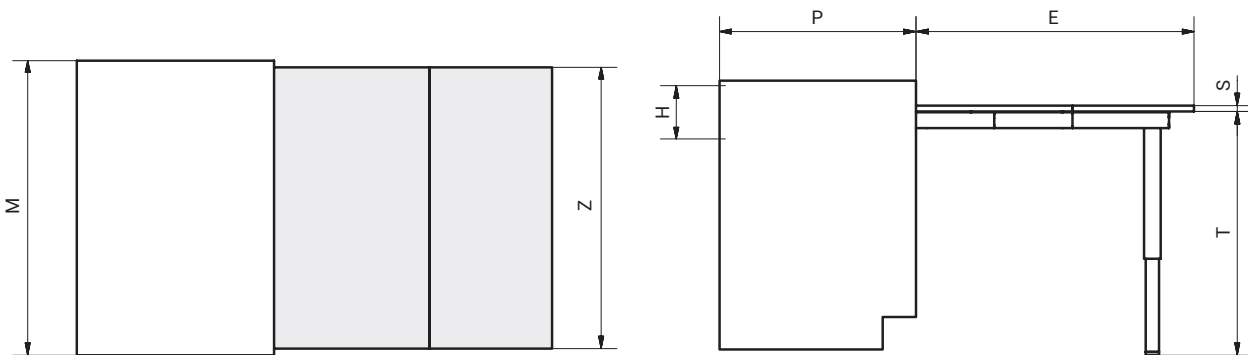

## T-Able

CODICE CODE	M	P MIN	H MIN	S1	E	Z MIN	S MIN	T	SILENT
411/78.1900.22	600	540	120	15/20	900	555	16	745/840	78.1900.22
411/78.1910.22	900	540	120	15/20	900	855	16	745/840	78.1910.22
411/78.1920.22	1200	540	120	15/20	900	1155	16	745/840	78.1920.22

Valori espressi in millimetri. Value expressed in millimetres.

Legenda tabella a pagina 112. Table key on page 112.

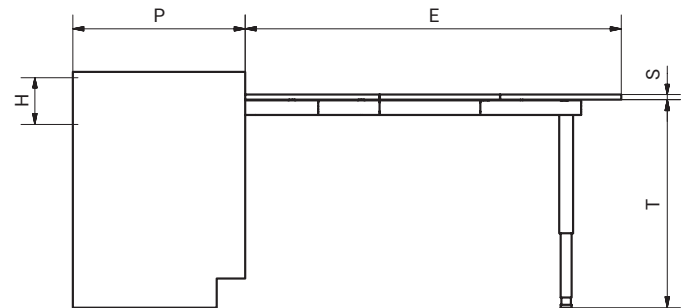
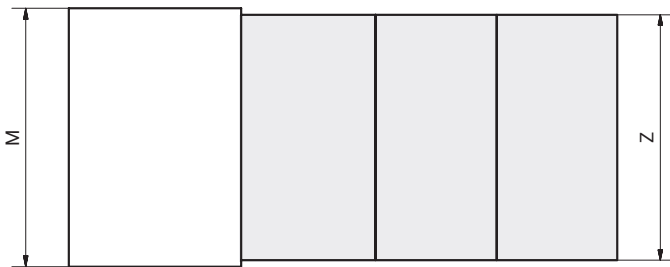

## T-Able XL

CODICE CODE	M	P MIN	H MIN.	S1	E	Z MIN	S MIN	T	SILENT
411/78.1900.22X	600	520	150	15/20	1310	555	16	700/795	78.1900.22X
411/78.1910.22X	900	520	150	15/20	1310	855	16	700/795	78.1910.22X
411/78.1920.22X	1200	520	150	15/20	1310	1155	16	700/795	78.1920.22X

Valori espressi in millimetri. Value expressed in millimetres.

Legenda tabella a pagina 112. Table key on page 112.

# Just

PIANO A RIBALTA CON GAMBA SINGOLA  
ABBATTIBILE TELESCOPICA  
TILTING TOP WITH SINGLE TELESCOPIC  
FOLDING LEG

DESIGN  
ATIM R&S / ATIM R&D

## FINITURA FINISHING

Inox Bronzino

## PORTATA LOAD CAPACITY

100 Kg equamente distribuiti  
100 Kg evenly distributed

## PACKAGING

118x18x8 cm

4 Kg

0,017 m<sup>3</sup>

## SCORRIMENTO SLIDING

Alluminio / Alluminio

Aluminium / Aluminium

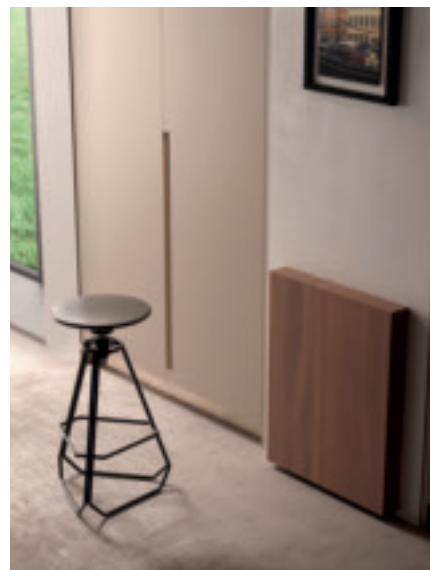

## NOTE

L'articolo non prevede la fornitura delle parti in legno.  
The item does not include the supply of wooden parts.

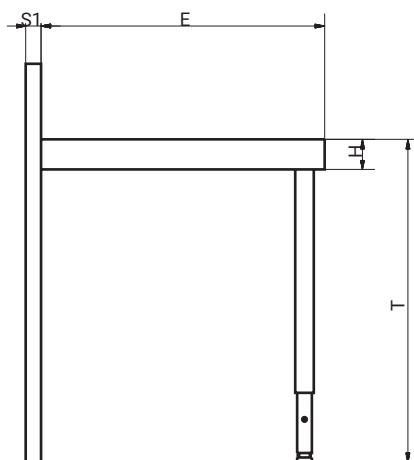
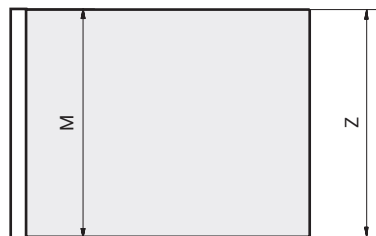

CODICE CODE	M	H MIN	T	S1 MIN	E	Z MIN	S MIN
411/78.1990.25	600	80	855	40	750	600	18

Valori espressi in millimetri. Value expressed in millimetres.

Legenda tabella a pagina 112. Table key on page 112.



# T-Bench / T-Bench XL

## DESIGN

Arch. Giulio Manzoni  
ATIM R&S / ATIM R&D

SEDUTA DA CASSETTO ESTRAIBILE  
CON GAMBA SINGOLA ABBATTIBILE  
PULL-OUT DRAWER BENCH  
WITH SINGLE FOLDING LEG

### FINITURA

#### FINISHING

Inox bronzino

### PORTATA

#### LOAD CAPACITY

100 Kg equamente distribuiti  
100 Kg evenly distributed

### PACKAGING

#### T-Bench

118x18x8 cm  
6,5 Kg  
0,017 m<sup>3</sup>

#### T-Bench XL

118x18x8 cm  
8 Kg  
0,017 m<sup>3</sup>

### SCORRIMENTO

#### SLIDING

Alluminio / Alluminio  
Aluminium / Aluminium

### OPTIONAL

su richiesta on request

#### KIT TAPPI

#### KIT CAPS

T-Bench  
2.9247231.XX

T-Bench XL  
2.9247251.XX

#### PIANO

#### TOP TABLE

Truciolare bianco  
White chipboard

T-Bench 450  
3.9132836.12 M

T-Bench 600  
3.9129876.12 M

T-Bench XL 600  
3.9155026.12 M

#### CERNIERE

#### HINGES

2.8016912.06  
2.8029912.12  
2.8048168.06

### NOTE

L'articolo non prevede la fornitura delle parti in legno.  
The item does not include the supply of wooden parts

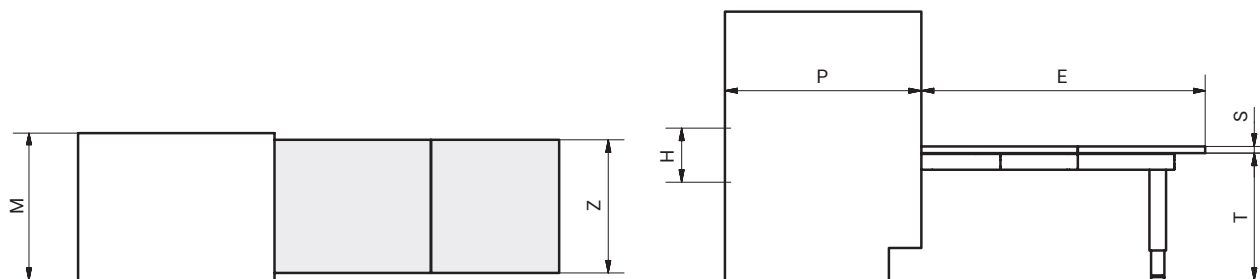

## T-Bench

CODICE CODE	M	P MIN	H MIN.	S1	E	Z MIN	S MIN	T	SILENT
411/78.1950.22	450	540	120	15/20	870	405	16	385/410	78.1950.22
411/78.1960.22	600	540	120	15/20	870	555	16	385/410	78.1960.22

Valori espressi in millimetri. Value expressed in millimetres.

Legenda tabella a pagina 112. Table key on page 112.



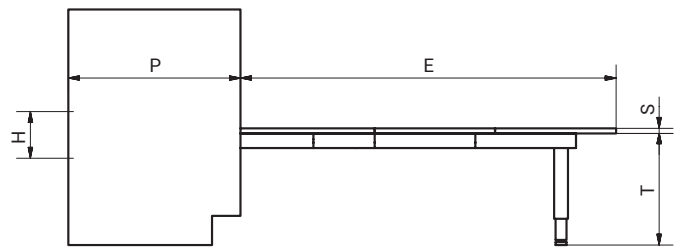

## T-Bench XL

CODICE CODE	M	P MIN	H MIN.	S1	E	Z MIN	S MIN	T	SILENT
411/78.1960.22X	600	520	150	15/20	1310	555	16	385/410	78.1960.22X

Valori espressi in millimetri. Value expressed in millimetres.

Legenda tabella a pagina 112. Table key on page 112.

# Party

TAVOLO DA CASSETTO ESTRAIBILE  
CON GAMBA DOPPIA ABBATTIBILE TELESCOPICA  
PULL-OUT DRAWER TABLE  
WITH DOUBLE TELESCOPIC FOLDING LEG

## DESIGN

Arch. Giulio Manzoni  
ATIM R&S / ATIM R&D

### FINITURA FINISHING

Inox Bronzino

### PORTATA LOAD CAPACITY

100 Kg equamente distribuiti  
100 Kg evenly distributed

### PACKAGING

118x18x8 cm  
11 Kg  
0,017 m<sup>3</sup>

### SCORRIMENTO SLIDING

Alluminio / Alluminio  
Aluminium / Aluminium

### OPTIONAL

su richiesta on request

### KIT TAPPI KIT CAPS

2.9247251.XX

### PIANO TOP TABLE

Truciolare bianco  
White chipboard

Party 600 3.9136476.12 M

Party 900 3.9136486.12 M

Party 1200 2.9136496.12 M

### CERNIERE HINGES

2.8016912.06

2.8029912.12

2.8048168.06



#### NOTE

L'articolo non prevede la fornitura delle parti in legno.  
The item does not include the supply of wooden parts

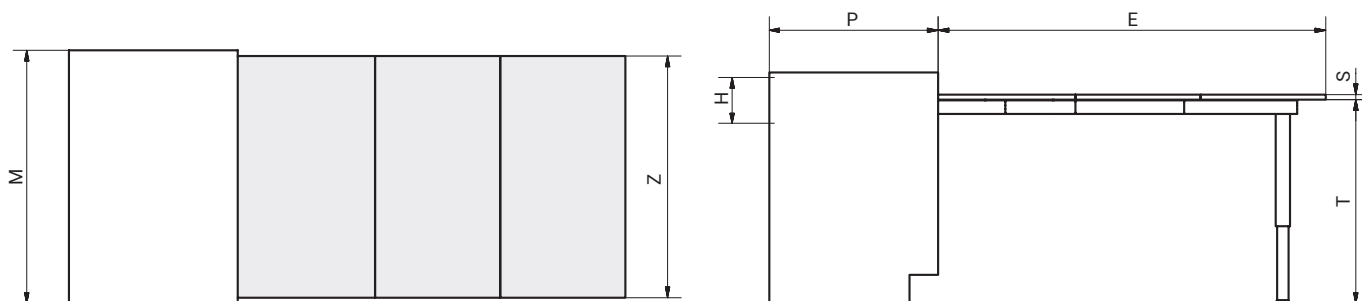

CODICE CODE	M	P MIN	H MIN	S1	E	Z MIN	S MIN	T	SILENT
411/78.1500.22	600	560	150	16/19	1380	557	16	725/820	78.1500.22
411/78.1510.22	900	560	150	16/19	1380	857	16	725/820	78.1510.22
411/78.1520.22	1200	560	150	16/19	1380	1157	16	725/820	78.1520.22

Valori espressi in millimetri. Value expressed in millimetres.

Legenda tabella a pagina 112. Table key on page 112.



# Mensola Party

TAVOLO DA CASSETTO ESTRAIBILE  
CON GAMBA DOPPIA ABBATTIBILE TELESCOPICA  
PULL-OUT DRAWER TABLE  
WITH DOUBLE TELESCOPIC FOLDING LEG

## DESIGN

Arch. Giulio Manzoni  
ATIM R&S / ATIM R&D

### FINITURA FINISHING

Inox Bronzino

### PORTATA LOAD CAPACITY

100 Kg equamente distribuiti  
100 Kg evenly distributed

### PACKAGING

105x34x8 cm  
14 Kg  
0,03 m<sup>3</sup>

### SCORRIMENTO SLIDING

Alluminio / Alluminio  
Aluminium / Aluminium

### OPTIONAL

*su richiesta on request*

### KIT TAPPI

#### KIT CAPS

2.9247281.XX



### NOTE

L'articolo non prevede la fornitura delle parti in legno.  
The item does not include the supply of wooden parts

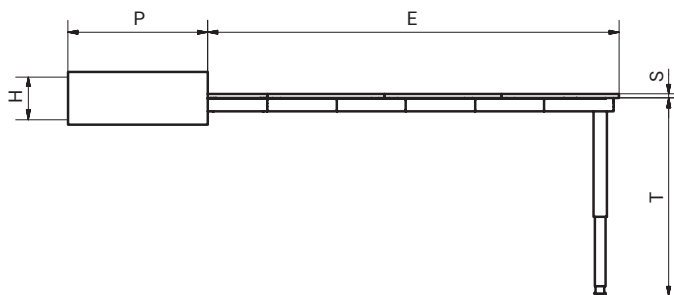
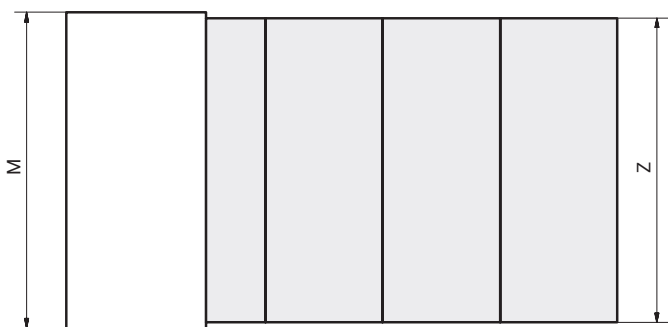

CODICE CODE	M	P MIN	H MIN	S1	E	Z MIN	S	T	SILENT
411/78.1601.22	600	502	140	18,5	1540	555	14	730/755	78.1601.22
411/78.1602.22	900	502	140	18,5	1540	855	14	730/755	78.1602.22
411/78.1600.22	1200	502	140	18,5	1540	1155	14	730/755	78.1600.22

Valori espressi in millimetri. Value expressed in millimetres.

Legenda tabella a pagina 112. Table key on page 112.



# Evolution / Evolution XL

TAVOLO DA CABINET ESTRAIBILE CON GAMBA A PONTE  
PULL-OUT CABINET TABLE WITH BRIDGE LEG

## DESIGN

Arch. Giulio Manzoni  
ATIM R&S / ATIM R&D

### FINITURA

#### FINISHING

Inox bronzino  
Guide/Slides

Grigio /Grey Ral 7012

Gamba/Leg

### VERSIONE NAKED (N)

#### NAKED VERSION (N)

Gamba

Nero opaco RAL 9005.

Senza traversi per fissaggio anta

Leg

Matt black RAL 9005.

Without bar for door fixing

### PORTATA

#### LOAD CAPACITY

100 Kg equamente distribuiti

100 Kg evenly distributed

### SCORRIMENTO

#### SLIDING

Alluminio / Alluminio

Aluminium / Aluminium

### PACKAGING (2 packages)

Guide/Slides

118x18x8 cm

6 Kg

0,017 m<sup>3</sup>

Gamba/Leg

Evolution 600

Evolution XL 600

57x77x8 cm

8 Kg

0,035 m<sup>3</sup>

Evolution 900

Evolution XL 900

87x88x8 cm

11 Kg

0,055 m<sup>3</sup>

Evolution 1200

Evolution XL 1200

117x88x8 cm

14 Kg

0,072 m<sup>3</sup>

### OPTIONAL

su richiesta on request

### KIT TAPPI

#### KIT CAPS

Evolution 2.9247241.XX

EvolutionXL 2.9247271.XX

### CERNIERE

#### HINGES

2.8016912.06

2.8029912.12

2.8048168.06

### PIANO

#### TOP TABLE

Evolution XL 900

3.9141776.12 M

#### NOTE

L'articolo non prevede la fornitura delle parti in legno.  
The item does not include the supply of wooden parts

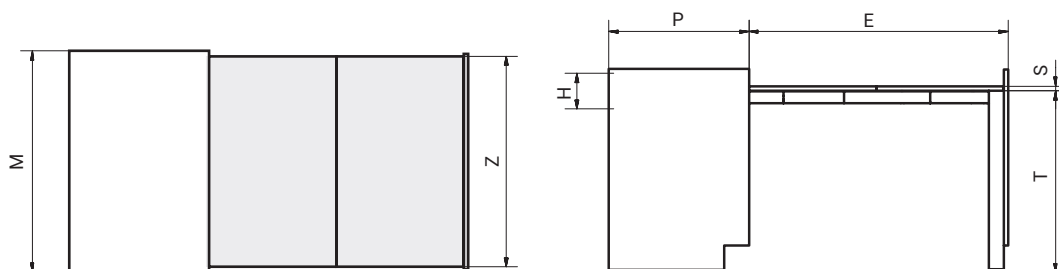

## Evolution

CODICE CODE	M	P MIN	H MIN	S1	E	Z MIN	S MIN	T	SILENT
411/78.1610.25	600	520	120	15/20	1040	555	16	730/755	78.1610.25
411/78.1611.25	900	520	120	15/20	1040	855	16	730/755	78.1611.25
411/78.1612.25	1200	520	120	15/20	1040	1155	16	730/755	78.1612.25
411/78.1610.25N	600	520	120	15/20	1040	555	16	730/755	78.1610.25N
411/78.1611.25N	900	520	120	15/20	1040	855	16	730/755	78.1611.25N
411/78.1612.25N	1200	520	120	15/20	1040	1155	16	730/755	78.1612.25N

Valori espressi in millimetri. Value expressed in millimetres.

Legenda tabella a pagina 112. Table key on page 112.

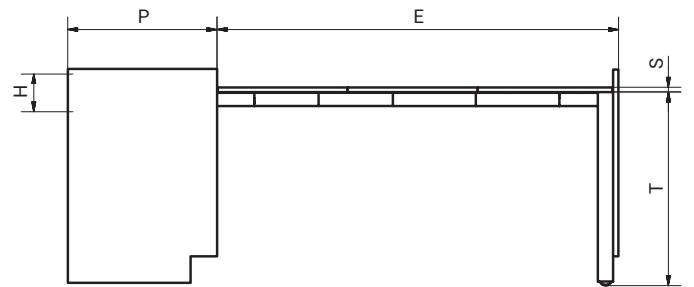

## Evolution XL

CODICE CODE	M	P MIN	H MIN	S1	E	Z MIN	S MIN	T	SILENT
411/78.1620.25	600	520	150	15/20	1520	555	16	730/755	78.1620.25
411/78.1621.25	900	520	150	15/20	1520	855	16	730/755	78.1621.25
411/78.1622.25	1200	520	150	15/20	1520	1155	16	730/755	78.1622.25
411/78.1620.25N	600	520	150	15/20	1520	555	16	730/755	78.1620.25N
411/78.1621.25N	900	520	150	15/20	1520	855	16	730/755	78.1621.25N
411/78.1622.25N	1200	520	150	15/20	1520	1155	16	730/755	78.1622.25N

Valori espressi in millimetri. Value expressed in millimetres.

Legenda tabella a pagina 112. Table key on page 112.

# Oplà Top

PIANO ESTRAIBILE FILO TOP  
PULL-OUT TOP ALLIGNED WITH COUNTER TOP

## DESIGN

Arch. Giulio Manzoni  
ATIM R&S / ATIM R&D

### FINITURA FINISHING

Inox Bronzino

### OPTIONAL

su richiesta on request

### PORTATA LOAD CAPACITY

40 Kg equamente distribuiti  
40 Kg evenly distributed

### KIT TAPPI

KIT CAPS

2.9247221.XX

### PACKAGING

118x18x8 cm

4,5 Kg

0,017 m<sup>3</sup>

### SCORRIMENTO

#### SLIDING

Alluminio / Alluminio

Aluminium / Aluminium

#### NOTE

L'articolo non prevede la fornitura delle parti in legno.  
The item does not include the supply of wooden parts

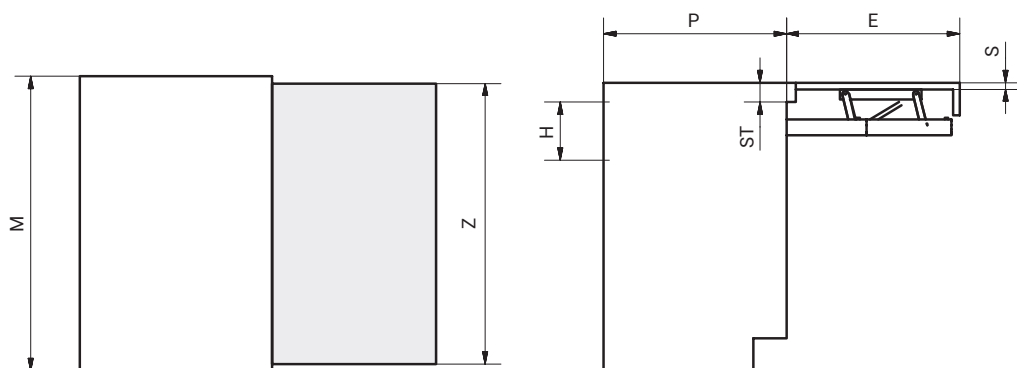

CODICE CODE	M	P MIN	H MIN	S1	E	Z MIN	S	ST	SILENT
411/78.1750.22	450	540	75	15/20	500	405	20/60	20/60	78.1750.22
411/78.1760.22	600	540	75	15/20	500	555	20/60	20/60	78.1760.22
411/78.1770.22	900	540	75	15/20	500	855	20/60	20/60	78.1770.22
411/78.1780.22	1200	540	75	15/20	500	1155	20/60	20/60	78.1780.22

Valori espressi in millimetri. Value expressed in millimetres.

Legenda tabella a pagina 112. Table key on page 112.





# Sandwich

TOP ESTRAIBILE CON EASYBOOK  
PULL-OUT TOP WITH EASYBOOK

## FINITURA FINISHING

Anodizzato naturale  
*Grigio satinato*

Anodised aluminium  
*Gray satin*

## PORTATA LOAD CAPACITY

80 Kg equamente distribuiti  
80 Kg evenly distributed

## PACKAGING

118x18x8 cm  
5,5 Kg  
0,017 m<sup>3</sup>

## SCORRIMENTO SLIDING

Cuscinetti a sfera  
Ball-bearing slide system

## OPTIONAL

*su richiesta on request*

**KIT TAPPI  
KIT CAPS**  
2.9250551.XX

**CERNIERE  
HINGES**  
2.8016912.06  
2.8029912.12  
2.8048168.06

## DESIGN

Arch. Giulio Manzoni  
ATIM R&S / ATIM R&D



NOTE  
L'articolo non prevede la fornitura delle parti in legno.  
The item does not include the supply of wooden parts.

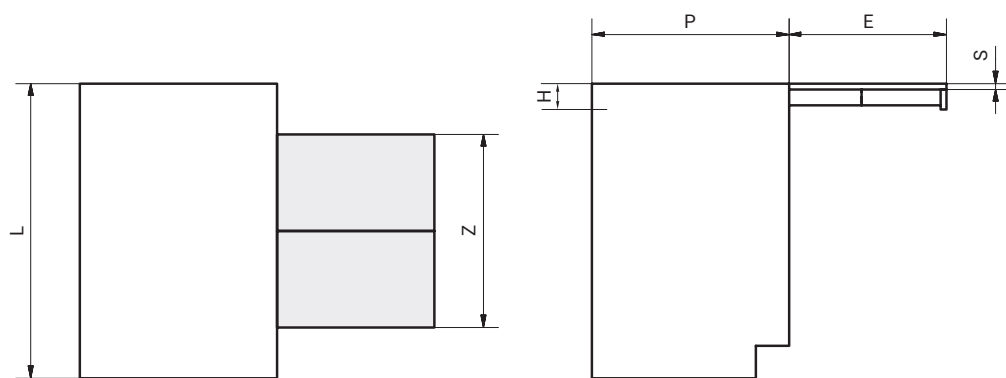

CODICE CODE	L MIN	P MIN	H MIN	E	Z	S
411/78.1850.22	592	540	80	510	590	18
411/78.1860.22	802	540	80	510	800	18
411/78.1870.22	1102	540	80	510	1100	18

Valori espressi in millimetri. Value expressed in millimetres.

Legenda tabella a pagina 112. Table key on page 112.



# Flip Top

PIANO DA CASSETTO ESTRAIBILE CON EASYBOOK  
PULL-OUT DRAWER WORKTOP WITH EASYBOOK

## DESIGN

Arch. Giulio Manzoni  
ATIM R&S / ATIM R&D

### FINITURA

#### FINISHING

Inox Bronzino

### PORTATA

#### LOAD CAPACITY

80 Kg equamente distribuiti  
80 Kg evenly distributed

### PACKAGING

118x18x8 cm  
5 Kg  
0,017 m<sup>3</sup>

### SCORRIMENTO

#### SLIDING

Alluminio / Alluminio  
Aluminium / Aluminium

### OPTIONAL

*su richiesta on request*

### KIT TAPPI

#### KIT CAPS

2.9247221.XX

### CERNIERE

#### HINGES

2.8016912.06  
2.8029912.12  
2.8048168.06



### NOTE

L'articolo non prevede la fornitura delle parti in legno.  
The item does not include the supply of wooden parts

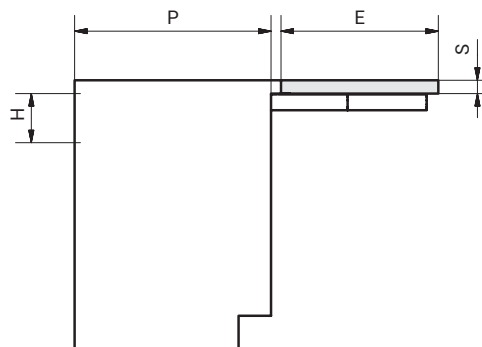
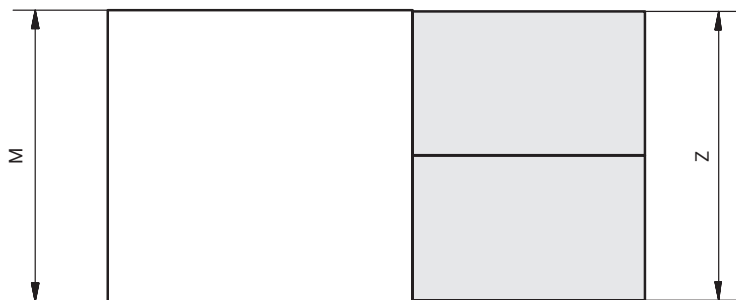

CODICE CODE	M	P MIN	H MIN	S1	E	Z MIN	S MIN	SILENT
411/78.1800.22	450	540	120	15/20	480	450	16	78.1800.22
411/78.1810.22	600	540	120	15/20	480	600	16	78.1810.22
411/78.1820.22	900	540	120	15/20	480	900	16	78.1820.22
411/78.1830.22	1200	540	120	15/20	480	1200	16	78.1830.22

Valori espressi in millimetri. Value expressed in millimetres.

Legenda tabella a pagina 112. Table key on page 112.



# Breakfast

PIANO ESTRAIBILE  
PULL-OUT TOP

## DESIGN

Arch. Giulio Manzoni  
ATIM R&S / ATIM R&D

### FINITURA FINISHING

Anodizzato naturale  
*Grigio satinato*

Anodised aluminium  
*Gray satin*

### PORTATA LOAD CAPACITY

60 Kg equamente distribuiti  
60 Kg evenly distributed

### PACKAGING

187x17x12 cm  
22 Kg  
0,04 m<sup>3</sup>

### SCORRIMENTO SLIDING

Cuscinetti a sfera  
Ball-bearing slide system

### OPTIONAL

*su richiesta on request*

**KIT TAPPI  
KIT CAPS**  
2.9250571.XX

### SOFT MOVE (SM)

Sistema scorrevole elettrificato  
con comando a distanza  
Electrified sliding system  
with remote control



#### NOTE

L'articolo non prevede la fornitura delle parti in legno.  
The item does not include the supply of wooden parts

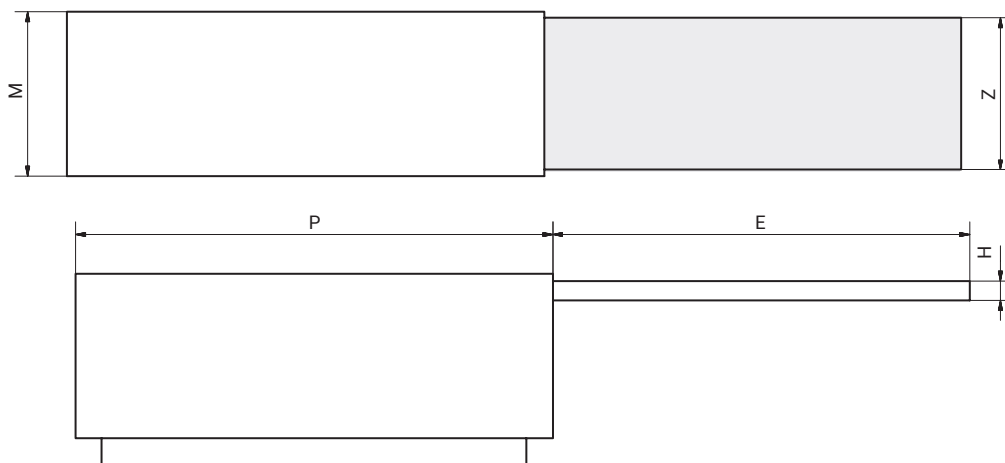

CODICE CODE	M MIN	P MIN	H MIN	E	Z MIN	S MIN
411/78.1251.22	600	1780	80	1600	580	18
411/78.1251 SM	600	1780	100	1600	580	18

Valori espressi in millimetri. Value expressed in millimetres.

Legenda tabella a pagina 112. Table key on page 112.



# Breakfast Top

PIANO SCORREVOLE SU TOP  
SLIDING TABLE TOP

## DESIGN

Arch. Giulio Manzoni  
ATIM R&S / ATIM R&D

### FINITURA FINISHING

Anodizzato naturale  
*Grigio satinato*

Anodised aluminium  
*Gray satin*

### PORTATA LOAD CAPACITY

60 Kg equamente distribuiti  
60 Kg evenly distributed

### PACKAGING

245x16x12 cm  
17 Kg  
0,05 m<sup>3</sup>

### SCORRIMENTO SLIDING

Cuscinetti a sfera  
Ball-bearing slide system

### OPTIONAL

*su richiesta on request*

### KIT TAPPI KIT CAPS 2.9250571.XX

### SOFT MOVE (SM)

Sistema scorrevole elettrificato  
con comando a distanza  
Electrified sliding system  
with remote control

H min = 150 mm

NOTE  
L'articolo non prevede la fornitura delle parti in legno.  
The item does not include the supply of wooden parts

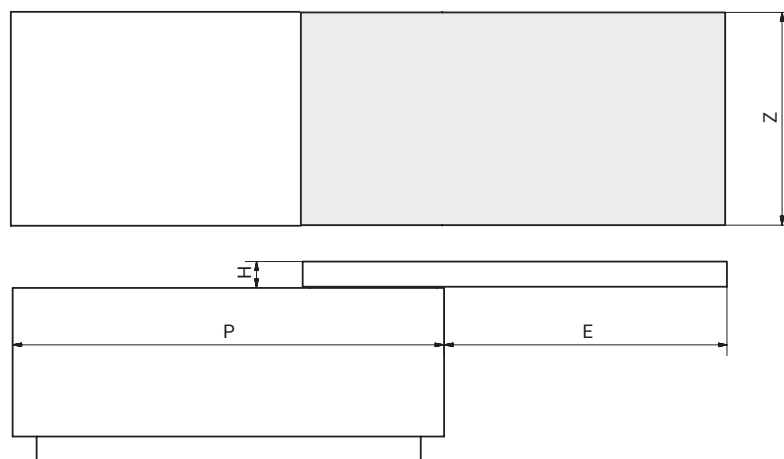

CODICE CODE	P MIN.	H MIN	Z MIN	E	S MIN
411/78.1252.22	1200	85	850	900	18
411/78.1253.22	1800	85	850	1200	18
411/78.1254.22	2400	85	850	1500	18
411/78.1255.22	3000	85	850	1500	18

Valori espressi in millimetri. Value expressed in millimetres.

Legenda tabella a pagina 112. Table key on page 112.





# Slide

DESIGN  
ATIM R&S / ATIM R&D

PIANO SCORREVOLE SU TOP  
SLIDING TABLE TOP

## FINITURA FINISHING

Anodizzato naturale  
*Grigio satinato*

Anodised aluminium  
*Gray satin*

## PORTATA

### LOAD CAPACITY

60 Kg equamente distribuiti  
60 Kg evenly distributed

## PACKAGING

118x46x7 cm  
9 Kg  
0,039 m<sup>3</sup>

## SCORRIMENTO SLIDING

Cuscinetti a sfera  
Ball-bearing slide system

## OPTIONAL

*su richiesta on request*

## KIT TAPPI KIT CAPS

2.9250551.XX



NOTE  
L'articolo non prevede la fornitura delle parti in legno.  
The item does not include the supply of wooden parts.

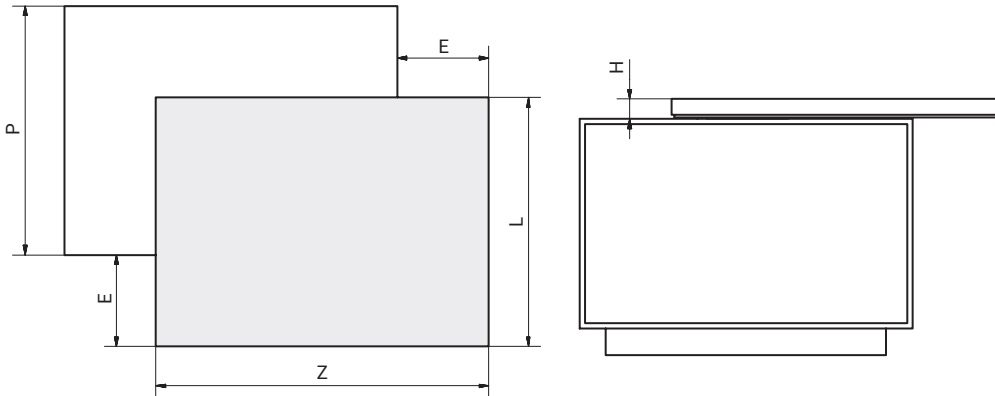

CODICE CODE	APERTURA OPENING	P MIN	H MIN	Z	L	S MIN	E
411/78.1241.22	SX/DX (L/R)	1200	75	1200	1200	18	350
411/78.1242.22	DX (R)	950	75	1200	950	18	350
411/78.1243.22	SX (L)	950	75	1200	950	18	350
411/78.1245.22	SX/DX (L/R)	900	75	900	900	18	315

Valori espressi in millimetri. Value expressed in millimetres.

Legenda tabella a pagina 112. Table key on page 112.



# Snack

PIANO SCORREVOLE  
SLIDING TABLE TOP

## FINITURA FINISHING

Anodizzato naturale  
Grigio satinato

Anodised aluminium  
Gray satin

## PORTATA

### LOAD CAPACITY

60 Kg equamente distribuiti  
60 Kg evenly distributed

## PACKAGING

411/78.1281.22 / SM  
245x27x8 cm 13,5 Kg 0,05 m<sup>3</sup>

411/78.1282.22 / SM  
180x27x8 cm 12 Kg 0,04 m<sup>3</sup>

## SCORRIMENTO SLIDING

Cuscinetti a sfera  
Ball-bearing slide system

## OPTIONAL

su richiesta on request

## KIT TAPPI

### KIT CAPS

2.9247461.XX

## SOFT MOVE (SM)

Sistema scorrevole elettrificato  
con comando a distanza  
Electrified sliding system  
with remote control

NOTE  
L'articolo non prevede la fornitura delle parti in legno.  
The item does not include the supply of wooden parts

## DESIGN

ATIM R&S / ATIM R&D

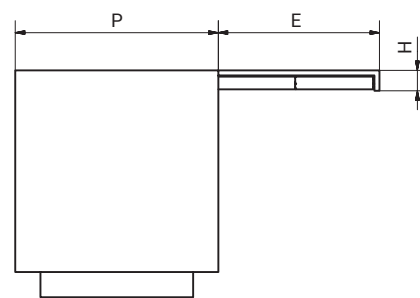
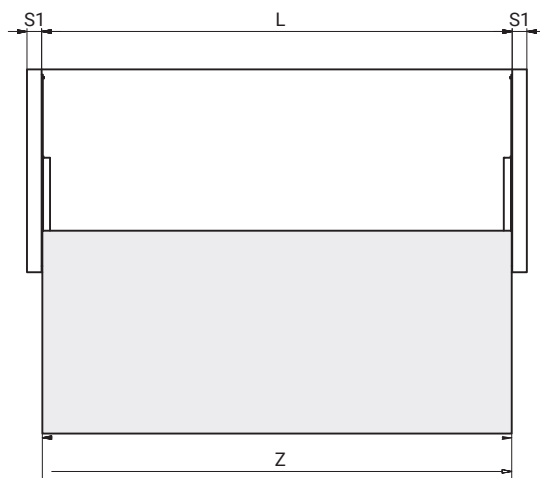

CODICE CODE	L	P MIN	H MIN	S1 MIN	E	S MIN	Z
411/78.1281.22	2467	800	80	40	640	18	2460
411/78.1282.22	1867	800	80	40	640	18	1860
411/78.1281 SM	2467	800	90	40	590	18	2460
411/78.1282 SM	1867	800	90	40	590	18	1860

Valori espressi in millimetri. Value expressed in millimetres.

Legenda tabella a pagina 112. Table key on page 112.



# Snack Top

PIANO SCORREVOLE SU TOP  
SLIDING TABLE TOP

DESIGN

ATIM R&S / ATIM R&D

## FINITURA FINISHING

Anodizzato naturale  
*Grigio satinato*

Anodised aluminium  
*Gray satin*

## PORTATA

### LOAD CAPACITY

80 Kg equamente distribuiti  
80 Kg evenly distributed

## PACKAGING

411/78.1283.22

90x30x6 cm 9 Kg 0,015 m<sup>3</sup>

411/78.1284.22

120x30x6 cm 13 Kg 0,02 m<sup>3</sup>

## SCORRIMENTO SLIDING

Cuscinetti a sfera

Ball-bearing slide system

## VERSIONE AIR (A) AIR VERSION (A)

Sistema di selfclosing, blumotion  
in apertura. montato al meccanismo.

Self-closing system, blumotion  
mounted to the mechanism.



### NOTE

L'articolo non prevede la fornitura delle parti in legno.  
The item does not include the supply of wooden parts

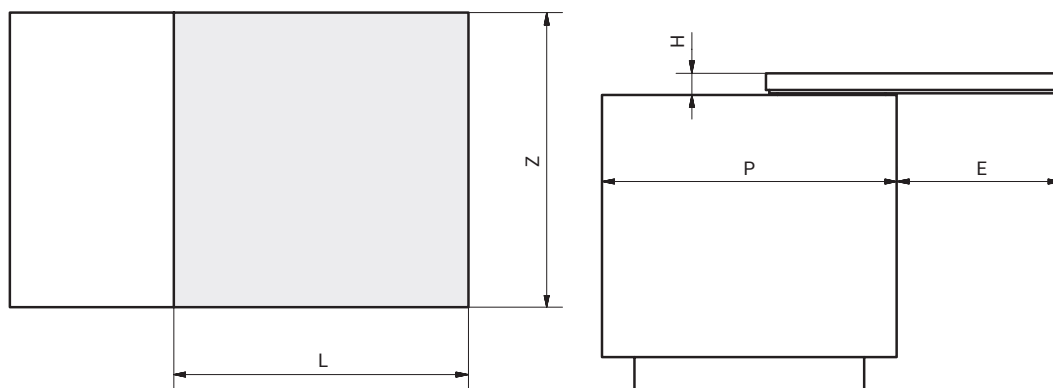

CODICE CODE	P MIN	Z MIN	L MIN	H MIN	E	S MIN	AIR
411/78.1283.22	900	900	900	65	500	18	411/78.1283.22A
411/78.1284.22	1200	1200	1200	65	700	18	411/78.1284.22A

Valori espressi in millimetri. Value expressed in millimetres.

Legenda tabella a pagina 112. Table key on page 112.



# Flap

PIANO SCORREVOLE SU TOP  
SLIDING TABLE TOP

## FINITURA FINISHING

Anodizzato naturale  
*Grigio satinato*

Anodised aluminium  
*Gray satin*

## PORTATA

### LOAD CAPACITY

80 Kg equamente distribuiti  
80 Kg evenly distributed

## PACKAGING

118x19x15 cm

9 Kg

0,035 m<sup>3</sup>

## SCORRIMENTO

### SLIDING

Cuscinetti a sfera

Ball-bearing slide system

## DESIGN

Arch. Giulio Manzoni

ATIM R&S / ATIM R&D



## NOTE

L'articolo non prevede la fornitura delle parti in legno.  
The item does not include the supply of wooden parts

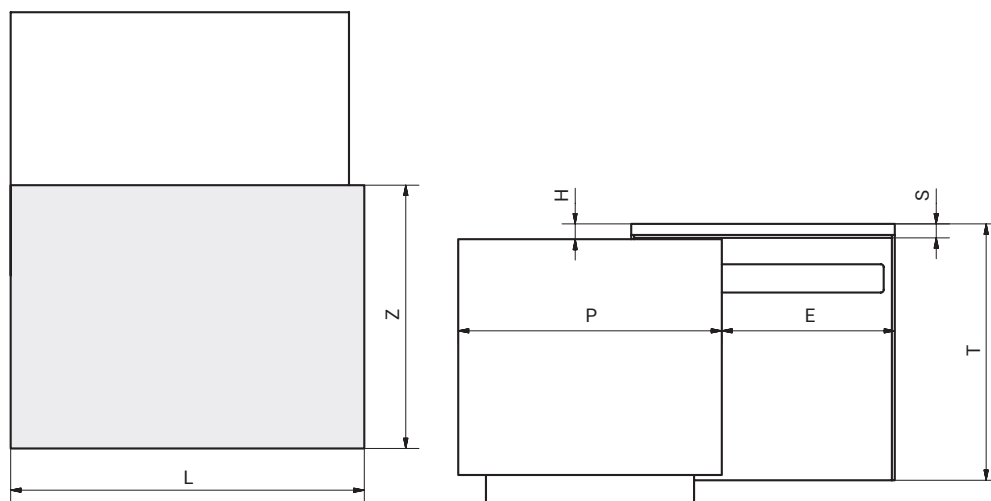

CODICE CODE	P MIN	H MIN	S MIN	E	L	Z	T MIN
411/78.1244.22	950	55	50	600	600/1300	950	450
411/78.1244.22 C	950	55	50	300	600/1300	950	450

Valori espressi in millimetri. Value expressed in millimetres.

Legenda tabella a pagina 112. Table key on page 112.





# Corner

PIANO SCORREVOLE SU TOP  
SLIDING TABLE TOP

## DESIGN

Arch. Giulio Manzoni  
ATIM R&S / ATIM R&D

### FINITURA FINISHING

Inox bronzino

### PORTATA LOAD CAPACITY

60 Kg equamente distribuiti  
60 Kg evenly distributed

### PACKAGING

118x46x7 cm  
9 Kg  
0,039 m<sup>3</sup>

### SCORRIMENTO SLIDING

Alluminio / Alluminio  
Aluminium / Aluminium

### OPTIONAL

su richiesta on request

### KIT TAPPI KIT CAPS

2.9247221.XX

### CORNICE STICK STICK FRAME

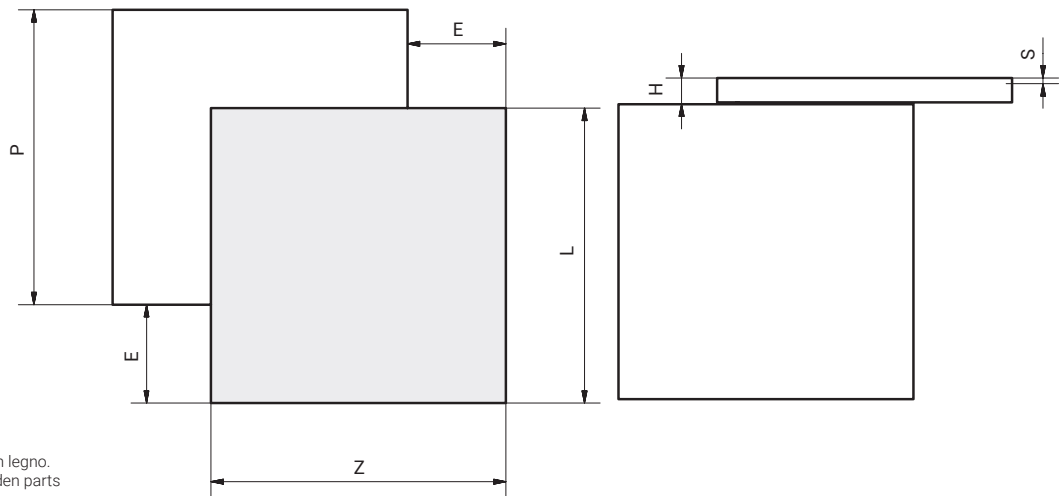

NOTE  
L'articolo non prevede la fornitura delle parti in legno.  
The item does not include the supply of wooden parts

CODICE CODE	AP	P MIN	H MIN	Z	L	S MIN	E
78.1230.25	SX/DX (L/R)	1200	80	1200	1200	18	350
78.1231.25	DX (R)	900	80	1200	900	18	350
78.1232.25	SX (L)	900	80	1200	900	18	350
78.1233.25	SX/DX (L/R)	900	80	900	900	18	300
78.1234.25	DX (R)	600	80	900	600	18	300
78.1235.25	SX (L)	600	80	900	600	18	300

Valori espressi in millimetri. Value expressed in millimetres.

Legenda tabella a pagina 112. Table key on page 112.



# Twice

PIANO SCORREVOLE  
SLIDING TOP

**FINITURA  
FINISHING**

Inox bronzino

**PORTATA  
LOAD CAPACITY**

60 Kg equamente distribuiti  
60 Kg evenly distributed

**PACKAGING**

118x46x7 cm  
9 Kg  
0,039 m<sup>3</sup>

**SCORRIMENTO  
SLIDING**

Alluminio / Alluminio  
Aluminium / Aluminium

**OPTIONAL**

*su richiesta on request*

**KIT TAPPI  
KIT CAPS**

2.9247221.XX

**CORNICE STICK  
STICK FRAME**

**DESIGN**

Arch. Giulio Manzoni  
ATIM R&S / ATIM R&D



NOTE  
L'articolo non prevede la fornitura delle parti in legno.  
The item does not include the supply of wooden parts

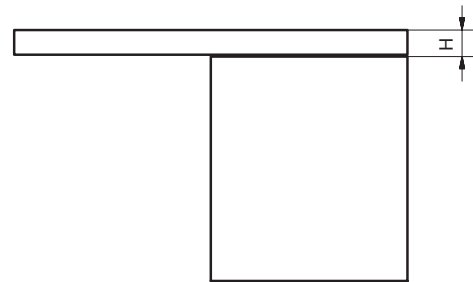
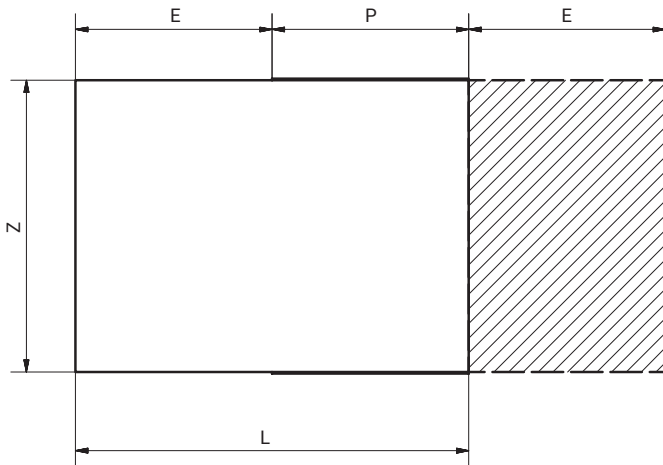

CODICE CODE	P MIN	H MIN	Z MIN	L MAX	S MIN	E MAX
411/78.1480.25	600	80	600	1200	18	600

Valori espressi in millimetri. Value expressed in millimetres.

Legenda tabella a pagina 112. Table key on page 112.



# Twice Top

PIANO SCORREVOLE SU TOP  
SLIDING TABLE TOP

## FINITURA FINISHING

Inox bronzino

## PORTATA LOAD CAPACITY

60 Kg equamente distribuiti  
60 Kg evenly distributed

## PACKAGING

190x50x7 cm  
10 Kg  
0,07 m<sup>3</sup>

## SCORRIMENTO SLIDING

Alluminio / Alluminio  
Aluminium / Aluminium

## OPTIONAL

*su richiesta on request*

## KIT TAPPI KIT CAPS

2.9247221.XX

## CORNICE STICK STICK FRAME

## DESIGN

Arch. Giulio Manzoni  
ATIM R&S / ATIM R&D



## NOTE

L'articolo non prevede la fornitura delle parti in legno.  
The item does not include the supply of wooden parts

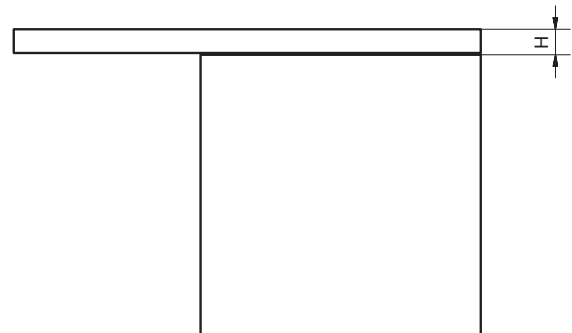
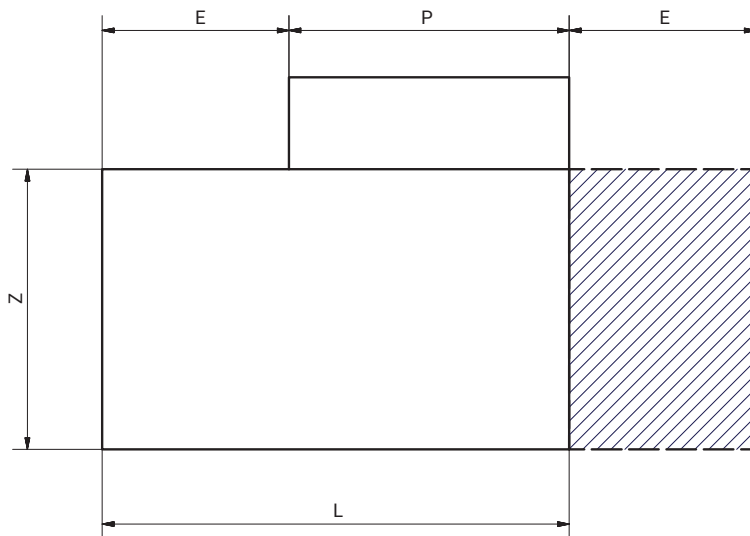

CODICE CODE	P	H MIN	Z MIN	L	S MIN	E
411/78.1470.25	900	80	900	1500	18	600
411/78.1471.25	1200	80	900	1800	18	600

Valori espressi in millimetri. Value expressed in millimetres.

Legenda tabella a pagina 112. Table key on page 112.



# Top 33

PIANO SCORREVOLE SU TOP  
SLIDING TABLE TOP

## FINITURA FINISHING

Anodizzato naturale (Grigio satinato)  
Anodised aluminium (Gray satin)

## PORTATA LOAD CAPACITY

60 Kg equamente distribuiti  
60 Kg evenly distributed

## PACKAGING

120x30x6 cm  
13 Kg  
0,03 m<sup>3</sup>

## SCORRIMENTO SLIDING

Cuscinetti a sfera  
Ball-bearing slide system

DESIGN  
ATIM R&S / ATIM R&D



NOTE  
L'articolo non prevede la fornitura delle parti in legno.  
The item does not include the supply of wooden parts

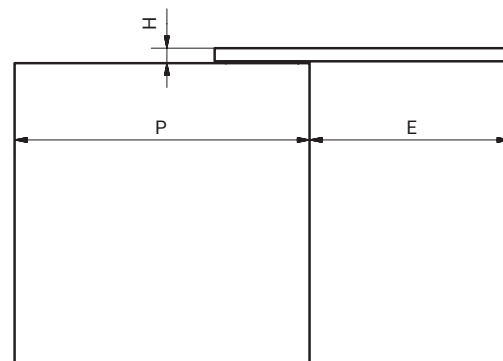
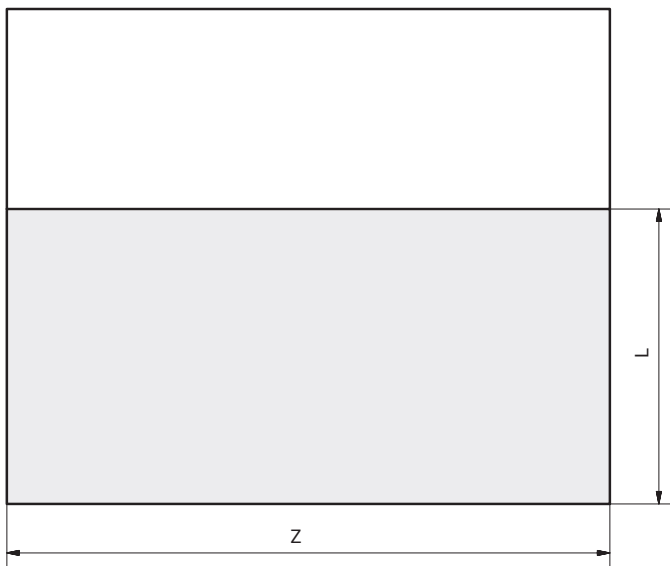

CODICE CODE	P	H MIN	Z MIN	L	S MIN	E
411/78.1270.22	900	45	1800	900	12	610
411/78.1271.22	1200	45	1800	1200	12	710

Valori espressi in millimetri. Value expressed in millimetres.

Legenda tabella a pagina 112. Table key on page 112.





# Voilà / Voilà Flag

DESIGN  
ATIM R&S / ATIM R&D

PIANO ESTRAIBILE CON GAMBE  
PULL-OUT TOP TABLE WITH LEGS

## FINITURA FINISHING

Inox bronzino

## PORTATA LOAD CAPACITY

100 Kg equamente distribuiti  
100 Kg evenly distributed

## PACKAGING

105x87x14  
13,5  
0,13 m<sup>3</sup>

## SCORRIMENTO SLIDING

Alluminio / Alluminio  
Aluminium / Aluminium

## OPTIONAL

*su richiesta on request*

## KIT TAPPI KIT CAPS

2.9247311.XX

## CERNIERE HINGES

2.8016912.06  
2.8029912.12  
2.8048168.06



NOTE  
L'articolo non prevede la fornitura delle parti in legno.  
The item does not include the supply of wooden parts

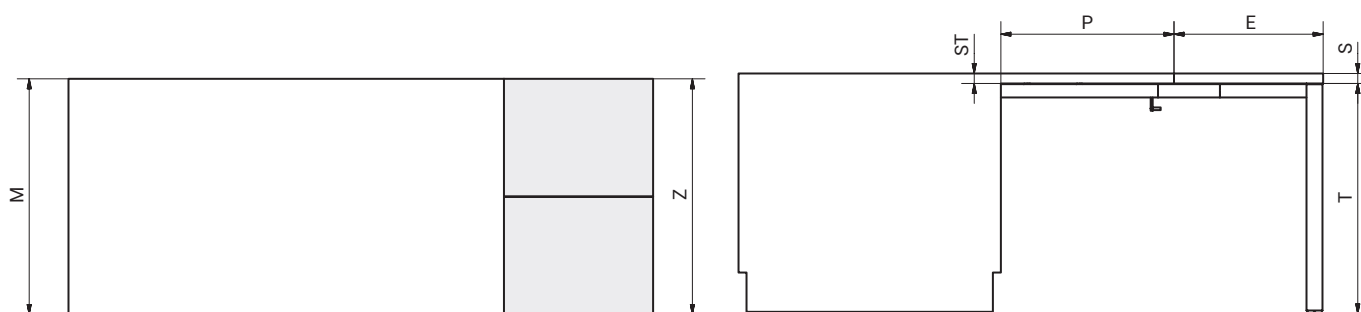

## Voilà

CODICE CODE	M	P MIN	E	Z	S	ST	T	GAMBA LEG	SILENT
411/78.1190.25	900	660	570	900	20/40	20/40	865/890	60X60	78.1190.25
411/78.1194.25	800	660	570	800	20/40	20/40	865/890	60X60	78.1194.25
411/78.1195.25	955	660	570	955	20/40	20/40	865/890	60X60	78.1195.25

Valori espressi in millimetri. Value expressed in millimetres.

Legenda tabella a pagina 112. Table key on page 112.

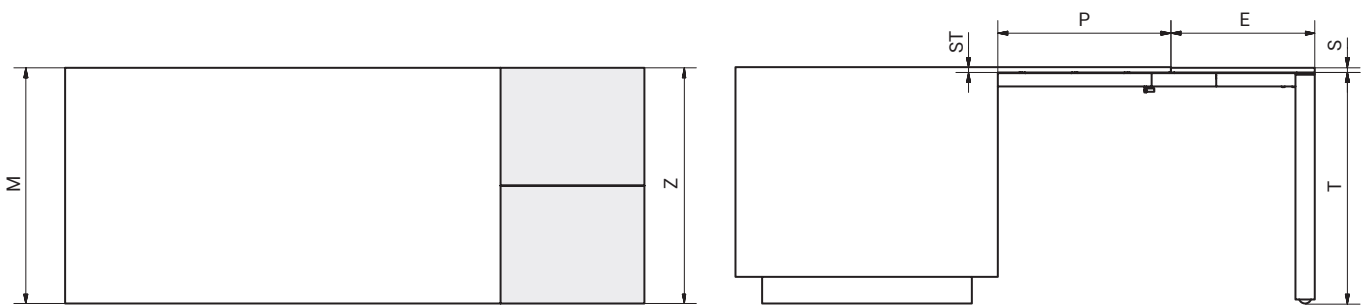

## Voilà Flag

CODICE CODE	M	P MIN	E	Z	S	ST	T	GAMBA LEG	SILENT
411/78.1197.25	900	660	550	900	20	20	865/890	72X45	78.1197.25
411/78.1198.25	900	660	550	900	40	40	865/890	72X45	78.1198.25

Valori espressi in millimetri. Value expressed in millimetres.

Legenda tabella a pagina 112. Table key on page 112.

# Voilà Chair

PIANO ESTRAIBILE CON GAMBE  
PULL-OUT TOP TABLE WITH LEGS

DESIGN  
ATIM R&S / ATIM R&D

## FINITURA FINISHING

Inox Bronzino

## PORTATA LOAD CAPACITY

100 Kg equamente distribuiti  
100 Kg evenly distributed

## PACKAGING

(2 packages)  
95x85x10 cm 5 Kg 0,6 m<sup>3</sup>  
80x20x10 cm 5 Kg 0,016 m<sup>3</sup>

## SCORRIMENTO SLIDING

Alluminio / Alluminio  
Aluminium / Aluminium

## OPTIONAL

su richiesta on request

## KIT TAPPI KIT CAPS

2.9247311.XX

## CERNIERE HINGES

2.8016912.06  
2.8029912.12  
2.8048168.06

NOTE  
L'articolo non prevede la fornitura delle parti in legno.  
The item does not include the supply of wooden parts.

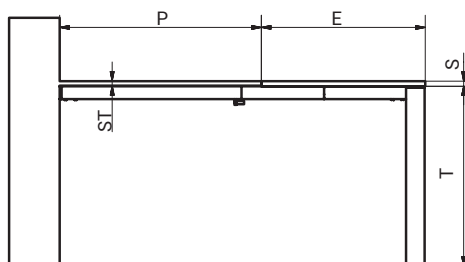
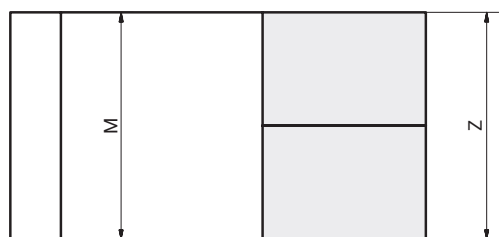

CODICE CODE	M	P MIN	E	Z	S	ST	T	GAMBA LEG	SILENT
411/78.1330.25	700	800	650	700	18/20	18/20	710/735	72X45	78.1330.25
411/78.1331.25	700	900	650	700	18/20	18/20	710/735	72X45	78.1331.25
411/78.1332.25	700	1000	650	700	18/20	18/20	710/735	72X45	78.1332.25
411/78.1333.25	800	800	650	800	18/20	18/20	710/735	72X45	78.1333.25
411/78.1334.25	800	900	650	800	18/20	18/20	710/735	72X45	78.1334.25
411/78.1335.25	800	1000	650	800	18/20	18/20	710/735	72X45	78.1335.25
411/78.1336.25	900	800	650	900	18/20	18/20	710/735	72X45	78.1336.25
411/78.1337.25	900	900	650	900	18/20	18/20	710/735	72X45	78.1337.25
411/78.1338.25	900	1000	650	900	18/20	18/20	710/735	72X45	78.1338.25

Valori espressi in millimetri. Value expressed in millimetres.

Legenda tabella a pagina 112. Table key on page 112.



# Voilà Chair Reverse

DESIGN  
ATIM R&S / ATIM R&D

PIANO ESTRAIBILE CON GAMBE  
PULL-OUT TOP TABLE WITH LEGS

## FINITURA FINISHING

Inox Bronzino

## PORTATA LOAD CAPACITY

100 Kg equamente distribuiti  
100 Kg evenly distributed

## PACKAGING

(2 packages)  
95x85x10 cm 5 Kg 0,6 m<sup>3</sup>  
80x20x10 cm 5 Kg 0,016 m<sup>3</sup>

## SCORRIMENTO SLIDING

Alluminio / Alluminio  
Aluminium / Aluminium

## OPTIONAL

su richiesta on request

## KIT TAPPI KIT CAPS

2.9247311.XX

## CERNIERE HINGES

2.8016912.06  
2.8029912.12  
2.8048168.06



## NOTE

L'articolo non prevede la fornitura delle parti in legno  
The item does not include the supply of wooden parts.

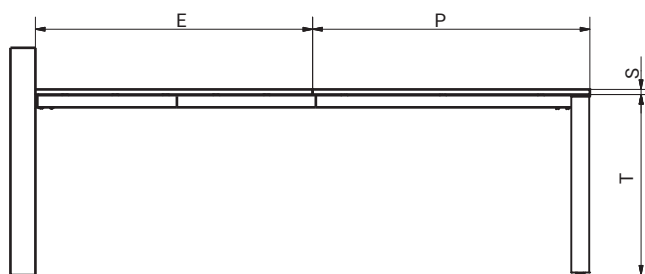
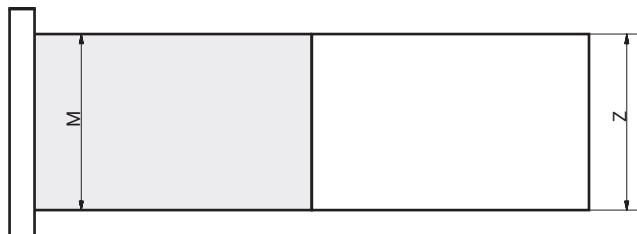

CODICE CODE	M	P	Z	S	ST	E MAX	T	GAMBA LEG	SILENT
411/78.1320.25	700	1100	700	18	18	1100	710/735	72X45	78.1320.25
411/78.1321.25	700	1300	700	18	18	1300	710/735	72X45	78.1321.25
411/78.1322.25	800	1100	800	18	18	1100	710/735	72X45	78.1322.25
411/78.1323.25	800	1300	800	18	18	1300	710/735	72X45	78.1323.25
411/78.1324.25	900	1100	900	18	18	1100	710/735	72X45	78.1324.25
411/78.1325.25	900	1300	900	18	18	1300	710/735	72X45	78.1325.25

Valori espressi in millimetri. Value expressed in millimetres.

Legenda tabella a pagina 112. Table key on page 112.



# Dinamico / Dinamico+

PIANO SCORREVOLE  
SLIDING TABLE TOP

## FINITURA FINISHING

Inox bronzino

## PORTATA LOAD CAPACITY

100 Kg equamente distribuiti  
100 Kg evenly distributed

## PACKAGING

*Meccanismo*

*Mechanism:*

42x18x6 8 Kg 0,005 m<sup>3</sup>

*Gola*

4300 mm 3,8 Kg 1 m<sup>3</sup>

## SCORRIMENTO SLIDING

**Dinamico**

Cuscinetti a sfera  
Ball-bearing slide system

**Dinamico+**

Alluminio / Alluminio  
+ Cuscinetti a sfera  
+ Ruote a pavimento  
Aluminium / Aluminium  
+ Ball-bearing slide system  
+ Floor wheels

## DESIGN

ATIM R&S / ATIM R&D

## OPTIONAL

*su richiesta on request*

## KIT TAPPI

**KIT CAPS**

2.9247311.XX

## CERNIERE

**HINGES**

2.8016912.06

2.8029912.12

2.8048168.06

## NOTE

L'articolo non prevede la fornitura delle parti in legno.  
L'articolo viene venduto con gola in barra 4300 mm.  
The item does not include the supply of wooden parts.  
The item is sold with a 4300 mm rod.

Gola

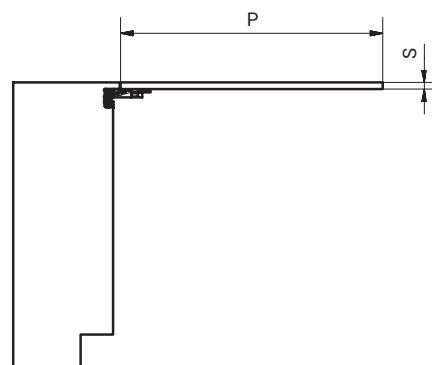
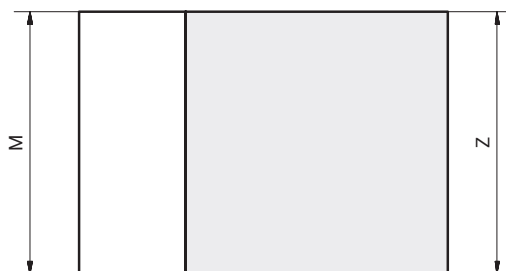
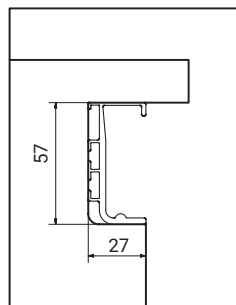

## Dinamico

PROFILO GOLA + STAFFE  
GOLA PROFILE + CARTS

CODICE CODE	M MIN	P MIN	Z MIN	S MIN
411/78.1301.25	500	500	500	20

Valori espressi in millimetri. Value expressed in millimetres.

Legenda tabella a pagina 112. Table key on page 112.



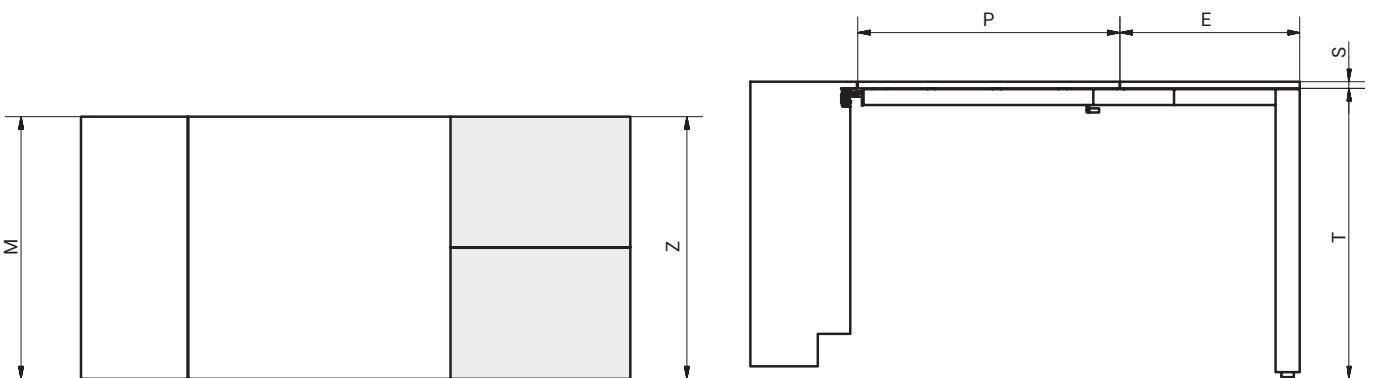

## Dinamico+

PROFILO GOLA+STAFFE+MECCANISMO ALLUNGABILE+GAMBA  
 GOLA PROFILE+CARTS+ EXTENDABLE MECHANISM+LEG)

CODICE CODE	M	P MIN	Z MIN	E	S	T	GAMBA LEG	SILENT
411/78.1192.25	800	800	800	570	20	865/890	72X45	78.1192.25
411/78.1193.25	800	800	800	570	40	865/890	72X45	78.1193.25

Valori espressi in millimetri. Value expressed in millimetres.

Legenda tabella a pagina 112. Table key on page 112.

# Sestante

PIANO SCORREVOLE E GIREVOLE  
SU TOP CON GAMBE  
SLIDING AND REVOLVING  
TABLE TOP WITH LEGS

## DESIGN

Arch. Giulio Manzoni  
ATIM R&S / ATIM R&D

### FINITURA FINISHING

Anodizzato naturale/ Anodised aluminium  
(Guide/Slides)

RAL 9005 Nero/Black  
(Gamba/Leg)

### PORTATA LOAD CAPACITY

80 Kg equamente distribuiti  
80 Kg evenly distributed

### PACKAGING

160XØ7 2.5 Kg 0,006 m<sup>3</sup>  
100x100x25 10 Kg 0,25 m<sup>3</sup>

### SCORRIMENTO SLIDING

Cuscinetti a sfera  
Ball-bearing slide system

#### NOTE

411/78.129X.22  
Articolo fornito senza gamba  
Item supplied without leg\*  
I codici con R sono forniti con gamba regolabile  
Items with R are supplied with adjustable leg\*

L'articolo non prevede la fornitura delle parti in legno  
The item does not include the supply of wooden parts.

> L'ARTICOLO È COPERTO DA BREVETTO  
THE ITEM IS PATENT PROTECTED

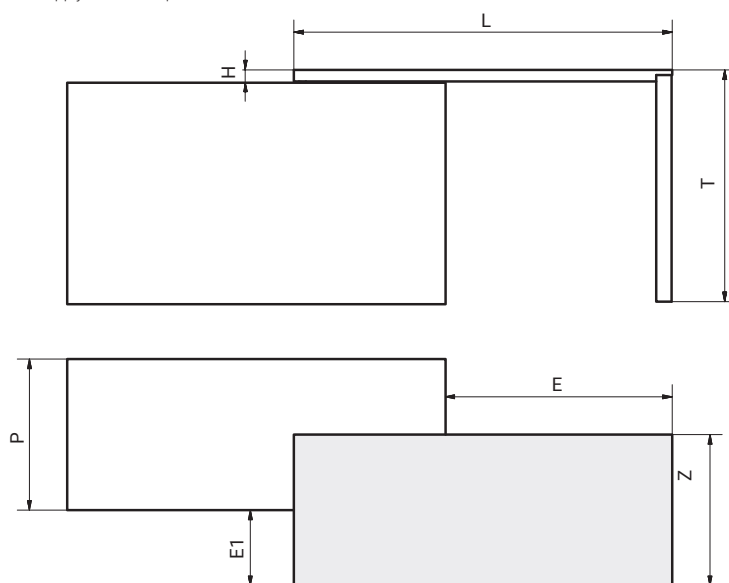

CODICE / CODE	P	L	T	H	E	E1	Z	S MIN
411/78.129X.22	-	1500	-	55	900	300	-	18
411/78.1290.22	600	1500	930	55	900	300	600	18
411/78.1291.22	700	1500	930	55	900	300	700	18
411/78.1292.22	800	1500	930	55	900	300	800	18
411/78.1293.22	900	1500	930	55	900	300	900	18
411/78.1293.22	1200	1500	930	55	900	300	1200	18
411/78.1290.22R	600	1500	800/960	55	900	300	600	18
411/78.1291.22R	700	1500	800/960	55	900	300	700	18
411/78.1292.22R	800	1500	800/960	55	900	300	800	18
411/78.1293.22R	900	1500	800/960	55	900	300	900	18
411/78.1293.22R	1200	1500	800/960	55	900	300	1200	18

Valori espressi in millimetri. Value expressed in millimetres.

Legenda tabella a pagina 112. Table key on page 112.



# Evolution +39 / Evolution XL +39

TAVOLO DA CABINET ESTRAIBILE CON GAMBA A PONTE  
PULL-OUT CABINET TABLE WITH BRIDGE LEG

## DESIGN

Arch. Giulio Manzoni  
ATIM R&S / ATIM R&D

### FINITURA

#### FINISHING

Inox bronzino  
Guide/Slides

Grigio /Grey Ral 7012  
Gamba/Leg

### VERSIONE NAKED (N) NAKED VERSION (N)

Gamba  
Nero opaco RAL 9005.  
Senza traversi per fissaggio anta  
Leg  
Matt black RAL 9005.  
Without bar for door fixing

### PORTATA

#### LOAD CAPACITY

100 Kg equamente distribuiti  
100 Kg evenly distributed

### SCORRIMENTO

#### SLIDING

Alluminio / Alluminio  
Aluminium / Aluminium

### PACKAGING (2 packages)

Guide/Slides  
118x18x8 cm  
6 Kg  
0,017 m<sup>3</sup>

Gamba/Leg  
Evolution +39 600  
Evolution XL +39 600  
57x77x8 cm  
8 Kg  
0,035 m<sup>3</sup>

Evolution +39 900  
Evolution +39 XL 900  
87x88x8 cm  
11 Kg  
0,055 m<sup>3</sup>

Evolution +39 1200  
Evolution XL +39 1200  
117x88x8 cm  
14 Kg  
0,072 m<sup>3</sup>

### OPTIONAL

su richiesta on request

### KIT TAPPI

#### KIT CAPS

Evolution +39 2.9247241.XX  
Evolution XL +39 2.9247271.XX

### CERNIERE

#### HINGES

2.8016912.06  
2.8029912.12  
2.8048168.06

#### NOTE

L'articolo non prevede la fornitura delle parti in legno  
The item does not include the supply of wooden parts.

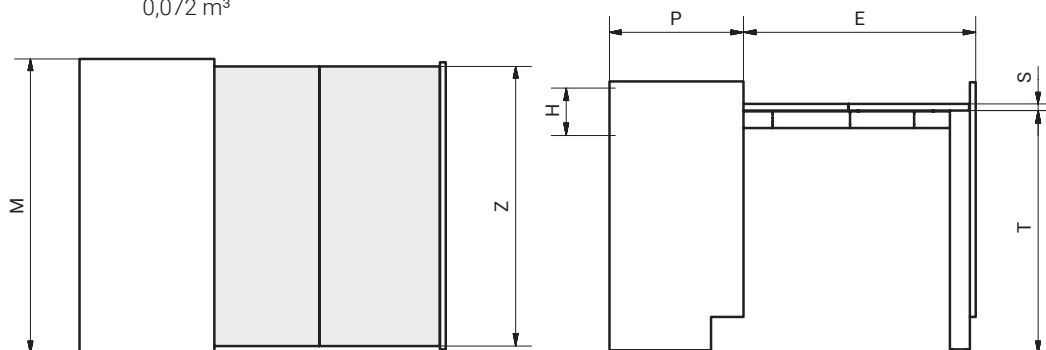

## Evolution +39

CODICE CODE	M	P MIN	H MIN	S1	E	S MIN	Z MIN	T	SILENT
411/39.1610.25	600	390	120	15/20	690	16	555	730/755	39.1610.25
411/39.1611.25	900	390	120	15/20	690	16	855	730/755	39.1611.25
411/39.1612.25	1200	390	120	15/20	690	16	1155	730/755	39.1612.25
411/78.1610.25N	600	520	120	15/20	1040	555	16	730/755	78.1610.25N
411/78.1611.25N	900	520	120	15/20	1040	855	16	730/755	78.1611.25N
411/78.1612.25N	1200	520	120	15/20	1040	1155	16	730/755	78.1612.25N

Valori espressi in millimetri. Value expressed in millimetres.

Legenda tabella a pagina 112. Table key on page 112.

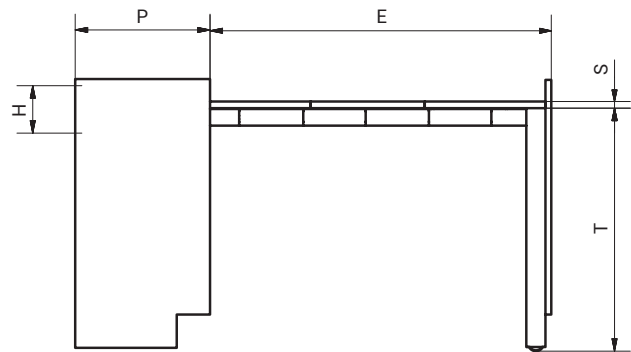
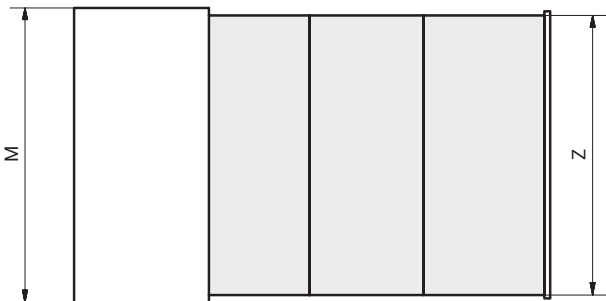

## Evolution XL +39

CODICE CODE	M	P MIN	H MIN	S1	E	S MIN	Z MIN	T	SILENT
411/39.1620.25	600	390	150	15/20	1025	16	555	730/755	39.1620.25
411/39.1621.25	900	390	150	15/20	1025	16	855	730/755	39.1621.25
411/39.1622.25	1200	390	150	15/20	1025	16	1155	730/755	39.1622.25
411/78.1620.25N	600	520	150	15/20	1520	555	16	730/755	78.1620.25N
411/78.1621.25N	900	520	150	15/20	1520	855	16	730/755	78.1621.25N
411/78.1622.25N	1200	520	150	15/20	1520	1155	16	730/755	78.1622.25N

Valori espressi in millimetri. Value expressed in millimetres.

Legenda tabella a pagina 112. Table key on page 112.

# Homework +39

TAVOLO ABBATTIBILE A SOFFIETTO  
FOLD-OUT TABLE

## DESIGN

Arch. Giulio Manzoni  
ATIM R&S / ATIM R&D

### FINITURA

#### FINISHING

Inox bronzino

### PORTATA

#### LOAD CAPACITY

40 Kg equamente distribuiti  
40 Kg evenly distributed

### PACKAGING

118x18x8 cm  
5 Kg  
0,017 m<sup>3</sup>

### SCORRIMENTO

#### SLIDING

Alluminio / Alluminio  
Aluminium / Aluminium

### OPTIONAL

*su richiesta on request*

### KIT TAPPI

#### KIT CAPS

2.9247251.XX

### KIT HOMEWORK

*Cerniere*

*Hinges*

*+ Blumotion*

2.9248320.XX

### NOTE

L'articolo non prevede la fornitura delle parti in legno  
The item does not include the supply of wooden parts.

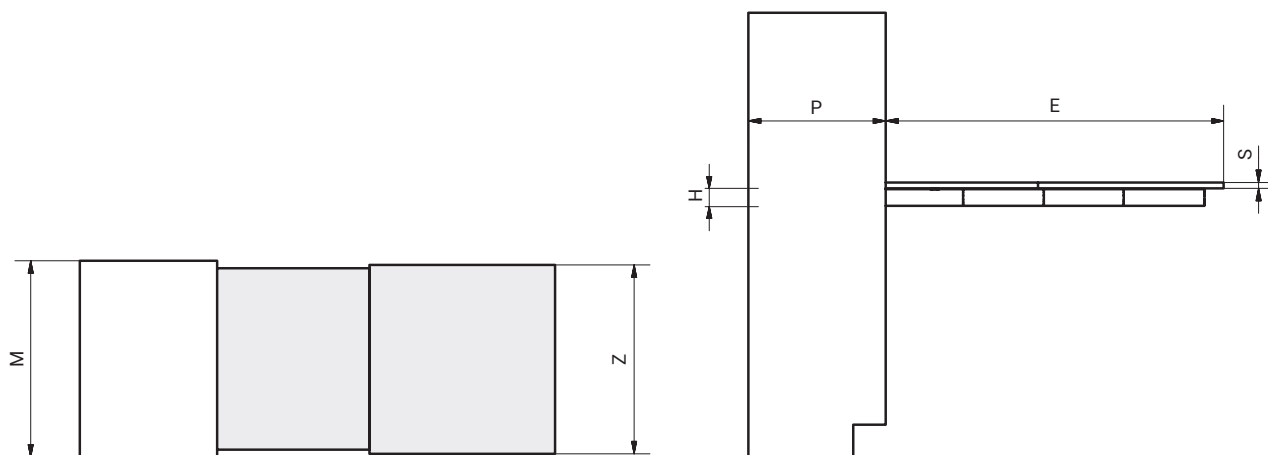

CODICE CODE	M	P MIN	H	S1	E	Z MIN	S MIN	SILENT
411/39.1200.25	600	390	54	15/20	1015	555	16	39.1200.25
411/39.1210.25	900	390	54	15/20	1015	855	16	39.1210.25
411/39.1220.25	1200	390	54	15/20	1015	1155	16	39.1220.25

Valori espressi in millimetri. Value expressed in millimetres.

Legenda tabella a pagina 112. Table key on page 112.



# Lunch +39

TAVOLO DA CASSETTO ESTRAIBILE  
PULL-OUT DRAWER TABLE

## DESIGN

Arch. Giulio Manzoni  
ATIM R&S / ATIM R&D

### FINITURA

#### FINISHING

Inox bronzino

### PORTATA

#### LOAD CAPACITY

60 Kg equamente distribuiti  
60 Kg evenly distributed

### PACKAGING

118x18x8 cm  
3,5 Kg  
0,017 m<sup>3</sup>

### SCORRIMENTO

#### SLIDING

Alluminio / Alluminio  
Aluminium / Aluminium

### OPTIONAL

*su richiesta on request*

### KIT TAPPI

#### KIT CAPS

2.9247231.XX

### CERNIERE

#### HINGES

2.8016912.06  
2.8029912.12  
2.8048168.06



### NOTE

L'articolo non prevede la fornitura delle parti in legno  
The item does not include the supply of wooden parts.

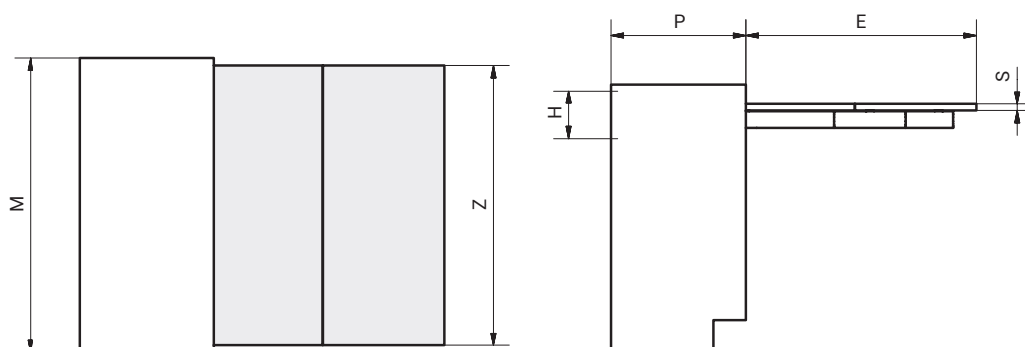

CODICE CODE	M	P MIN	H MIN	S1	E	Z MIN	S MIN	SILENT
411/39.1100.25	450/1200	390	120	15/20	705	405/1155	16	39.1100.25

Valori espressi in millimetri. Value expressed in millimetres.

Legenda tabella a pagina 112. Table key on page 112.





# Mensola T-Able +39

TAVOLO DA CASSETTO ESTRAIBILE CON GAMBA SINGOLA  
 ABBATTIBILE TELESCOPICA  
 PULL-OUT DRAWER TABLE WITH SINGLE  
 TELESCOPIC FOLDING LEG

## DESIGN

Arch. Giulio Manzoni  
 ATIM R&S / ATIM R&D

### FINITURA

#### FINISHING

Inox Bronzino

### OPTIONAL

*su richiesta on request*

### PORTATA

#### LOAD CAPACITY

100 Kg equamente distribuiti  
 100 Kg evenly distributed

### KIT TAPPI

#### KIT CAPS

2.9247261.XX

### PACKAGING

124x16x7 cm

8 Kg

0,14 m<sup>3</sup>

### SCORRIMENTO

#### SLIDING

Alluminio / Alluminio

Aluminium / Aluminium



### NOTE

L'articolo non prevede la fornitura delle parti in legno.  
 The item does not include the supply of wooden parts.

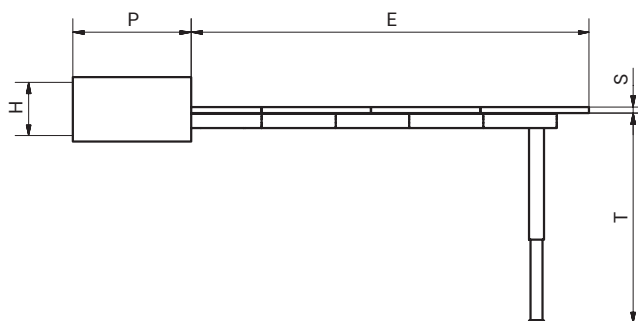
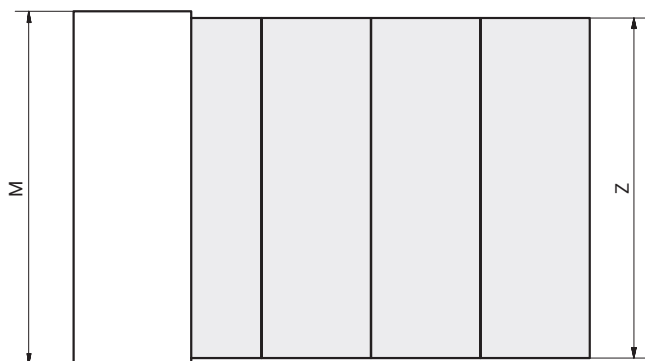

CODICE CODE	M	P MIN.	H MIN	S1	E	Z MIN	S MIN	T	SILENT
411/39.1920.25X	1200	390	180	15/20	1350	1155	14	712/737	39.1920.25X

Valori espressi in millimetri. Value expressed in millimetres.

Legenda tabella a pagina 112. Table key on page 112.



# Oplà +39

PIANO ESTRAIBILE FILO RIPIANO  
PULL-OUT TOP FLUSH WITH SHELF

## FINITURA FINISHING

Inox Bronzino

## PORTATA LOAD CAPACITY

40 Kg equamente distribuiti  
40 Kg evenly distributed

## PACKAGING

118x18x8 cm  
3 Kg  
0,017 m<sup>3</sup>

## SCORRIMENTO SLIDING

Alluminio / Alluminio  
Aluminium / Aluminium

## OPTIONAL

su richiesta on request

## KIT TAPPI KIT CAPS

2.9247221.XX

## DESIGN

Arch. Giulio Manzoni  
ATIM R&S / ATIM R&D



NOTE  
L'articolo non prevede la fornitura delle parti in legno  
The item does not include the supply of wooden parts.

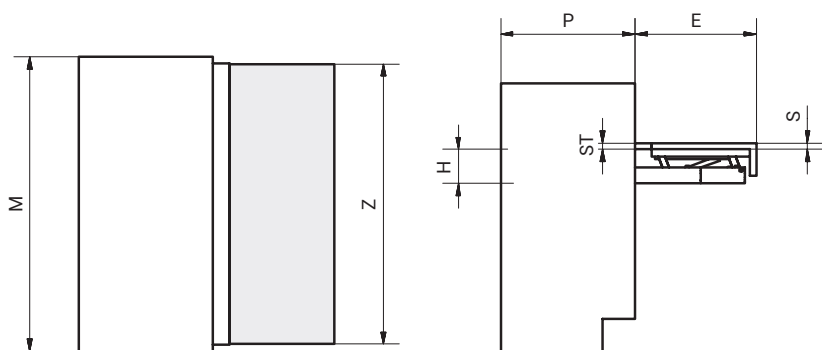

CODICE CODE	M	P MIN	H MIN	S1	E	S	ST	Z	SILENT
411/39.1700.25	450/1000	390	100	15/20	370	18/22	18/22	405/955	39.1700.25
411/39.1720.25	1200	390	100	15/20	370	18/22	18/22	1155	39.1720.25

Valori espressi in millimetri. Value expressed in millimetres.

Legenda tabella a pagina 112. Table key on page 112.



# Oplà Folding +39

PIANO ESTRAIBILE FILO RIPIANO  
PULL-OUT TOP FLUSH WITH SHELF

## DESIGN

Arch. Giulio Manzoni  
ATIM R&S / ATIM R&D

### FINITURA

#### FINISHING

Inox Bronzino

### PORTATA

#### LOAD CAPACITY

40 Kg equamente distribuiti  
40 Kg evenly distributed

### PACKAGING

118x18x8 cm  
3 Kg  
0,017 m<sup>3</sup>

### SCORRIMENTO

#### SLIDING

Alluminio / Alluminio  
Aluminium / Aluminium

### OPTIONAL

*su richiesta on request*

### KIT TAPPI

#### KIT CAPS

2.9247221.XX

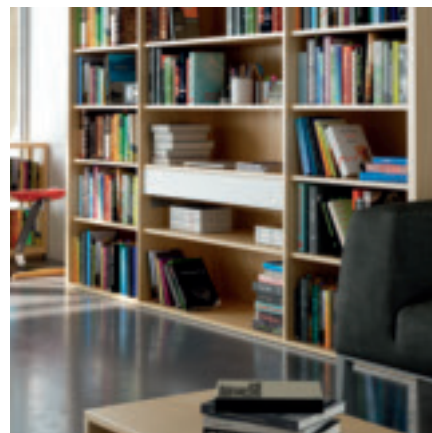

### NOTE

L'articolo non prevede la fornitura delle parti in legno  
The item does not include the supply of wooden parts.

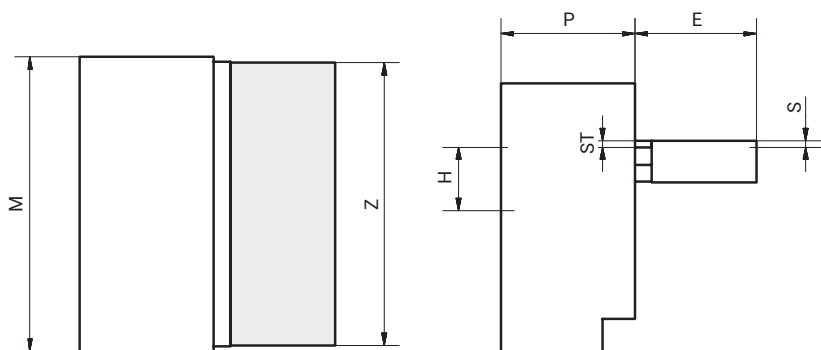

CODICE CODE	M	P MIN.	H MIN	S1	E	Z	S	ST	SILENT
411/39.1700.25 F	450/1000	390	205	15/20	370	405/955	16/25	16/25	39.1700.25 F
411/39.1720.25 F	1200	390	205	15/20	370	1155	16/25	16/25	39.1720.25 F

Valori espressi in millimetri. Value expressed in millimetres.

Legenda tabella a pagina 112. Table key on page 112.



# T-Bench +39

SEDUTA DA CASSETTO ESTRAIBILE  
CON GAMBA SINGOLA ABBATTIBILE  
PULL-OUT DRAWER BENCH  
WITH SINGLE FOLDING LEG

## DESIGN

Arch. Giulio Manzoni  
ATIM R&S / ATIM R&D

### FINITURA

#### FINISHING

Inox Bronzino

### PORTATA

#### LOAD CAPACITY

100 Kg equamente distribuiti

100 Kg evenly distributed

### PACKAGING

118x18x8 cm

5 Kg

0,017 m<sup>3</sup>

### SCORRIMENTO

#### SLIDING

Alluminio / Alluminio

Aluminium / Aluminium

### OPTIONAL

*su richiesta on request*

### KIT TAPPI

#### KIT CAPS

2.9247231.XX

### CERNIERE

#### HINGES

2.8016912.06

2.8029912.12

2.8048168.06

### NOTE

L'articolo non prevede la fornitura delle parti in legno  
The item does not include the supply of wooden parts.

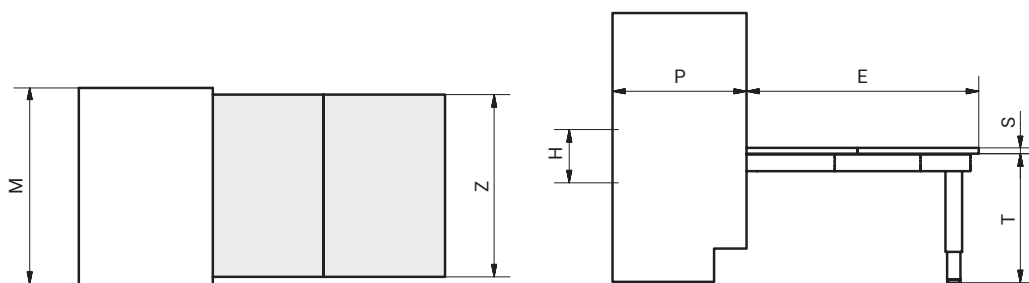

CODICE CODE	M	P MIN.	H MIN	S1	E	S MIN	Z MIN	T	SILENT
411/39.1950.25	450	390	120	15/20	705	16	405	395/420	39.1950.25
411/39.1960.25	600	390	120	15/20	705	16	555	395/420	39.1960.25

Valori espressi in millimetri. Value expressed in millimetres.

Legenda tabella a pagina 112. Table key on page 112.





# Shot+39

PIANO DA CASSETTO ESTRAIBILE  
PULL-OUT DRAWER WORKTOP

## DESIGN

Arch. Giulio Manzoni  
ATIM R&S / ATIM R&D

### FINITURA FINISHING

Inox Bronzino

### PORTATA LOAD CAPACITY

80 Kg equamente distribuiti  
80 Kg evenly distributed

### PACKAGING

118x18x8 cm

4 Kg

0,017 m<sup>3</sup>

### SCORRIMENTO SLIDING

Alluminio / Alluminio

Aluminium / Aluminium

### OPTIONAL

*su richiesta on request*

### KIT TAPPI

KIT CAPS

2.9247221.XX

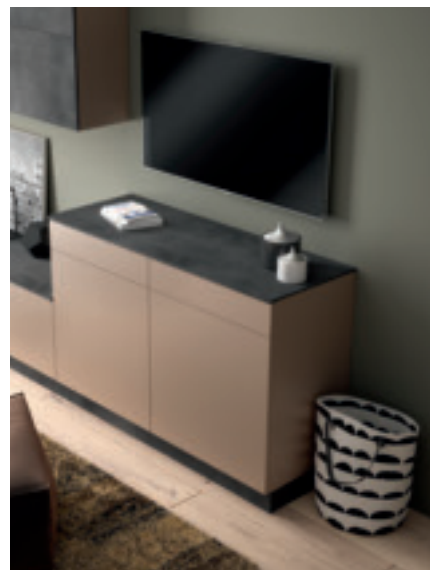

### NOTE

L'articolo non prevede la fornitura delle parti in legno.  
The item does not include the supply of wooden parts.

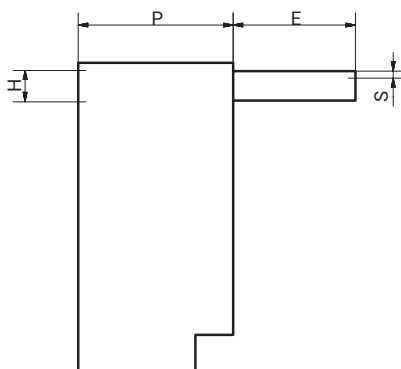
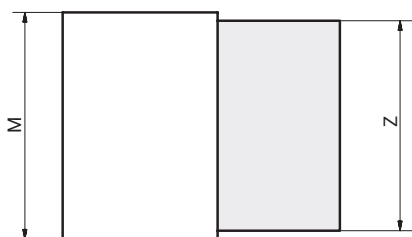

CODICE CODE	M MIN	P MIN	H MIN	S1	E	Z MIN	S MIN	SILENT
411/39.1130.25	450	390	90	15/20	325	405	16	39.1130.25
411/39.1130.25 F	450	390	90	15/20	325	405	16	39.1130.25 F

Valori espressi in millimetri. Value expressed in millimetres.

Legenda tabella a pagina 112. Table key on page 112.



# Prua

ASSE DA STIRO ESTRAIBILE  
PULL-OUT IRONING BOARD

## FINITURA FINISHING

Inox Bronzino

## PORTATA LOAD CAPACITY

80 Kg equamente distribuiti  
80 Kg evenly distributed

## PACKAGING

Prua  
60x36x12 cm  
7,5 Kg  
0,25 m<sup>3</sup>

## SCORRIMENTO SLIDING

Alluminio / Alluminio  
Aluminium / Aluminium

## PIANO TOP

Multistrato in betulla fenolico  
Phenolic birch plywood

## OPTIONAL

*su richiesta on request*

## KIT TAPPI KIT CAPS

2.9247241.XX

## PANNO DI RICAMBIO SPARE CLOTH

2.6535460.13

## DESIGN

Arch. Giulio Manzoni  
ATIM R&S / ATIM R&D



NOTE  
Articolo fornito di piano con tessuto grigio.  
Item supplied top with gray cloth.

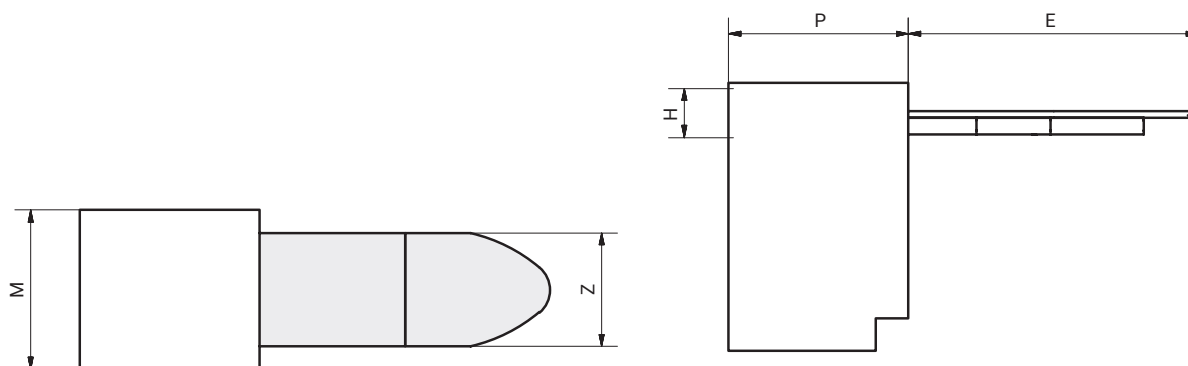

## Prua

CODICE CODE	M MIN	P MIN	H MIN	E	Z	SILENT
411/78.1180.22	360	535	150	885	350	78.1180.22

Valori espressi in millimetri. Value expressed in millimetres.

Legenda tabella a pagina 112. Table key on page 112.

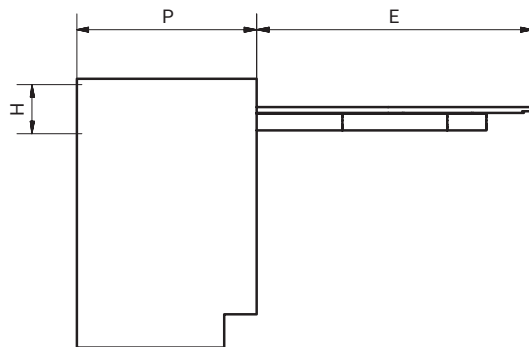
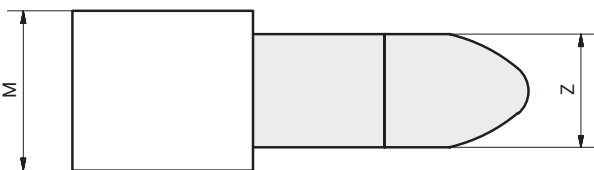

## Prua Short

CODICE CODE	M MIN	P MIN	H MIN.	E	Z	SILENT
411/78.1181.22	330	450	140	840	350	78.1181.22

Valori espressi in millimetri. Value expressed in millimetres.

Legenda tabella a pagina 112. Table key on page 112.

# Prua Lift

ASSE DA STIRO A RIBALTA  
TILTING IRONING BOARD

DESIGN  
ATIM R&S / ATIM R&D

## FINITURA FINISHING

Inox Bronzino

## PORTATA LOAD CAPACITY

50 Kg equamente distribuiti  
50 Kg evenly distributed

## PACKAGING

120x30x10 cm  
4 Kg  
0,036 m<sup>3</sup>

## PIANO TOP

Multistrato in betulla fenolico  
Phenolic birch plywood

## OPTIONAL

*su richiesta on request*

## PANNO DI RICAMBIO SPARE CLOTH

Prua Lift 350 2.6551940.13

Prua Lift 450 2.6552110.13



NOTE  
Articolo fornito di piano con tessuto grigio  
Item supplied top with gray cloth

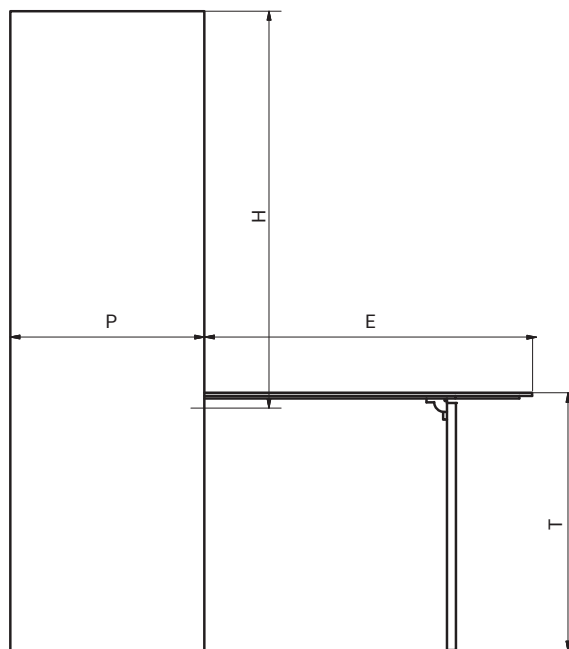
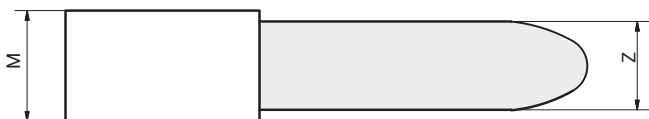

CODICE CODE	M	P MIN	H MIN	S1	E	Z	T
411/78.1186.22	350	100	1100	15/20	1050	280	820
411/78.1187.22	450	100	1100	15/20	1050	380	820

Valori espressi in millimetri. Value expressed in millimetres.

Legenda tabella a pagina 112. Table key on page 112.



# Prua Swing

ASSE DA STIRO ROTANTE  
REVOLVING PULL-OUT IRONING BOARD

DESIGN  
ATIM R&S / ATIM R&D

## FINITURA FINISHING

Inox bronzino

## PORTATA LOAD CAPACITY

40 Kg equamente distribuiti  
40 Kg evenly distributed

## PACKAGING

100x40x6 cm  
5 Kg  
0,025 m<sup>3</sup>

## ROTAZIONE REVOLVING

Piastra in ferro zincato  
Galvanized iron plate

## PIANO TOP

Multistrato in betulla fenolico  
Phenolic birch plywood

## OPTIONAL

su richiesta on request

## PANNO DI RICAMBIO SPARE CLOTH

2.6535460.13

NOTE  
Articolo fornito di panno con tessuto grigio  
Item supplied top with gray cloth

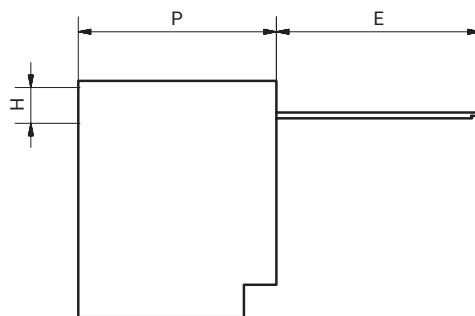
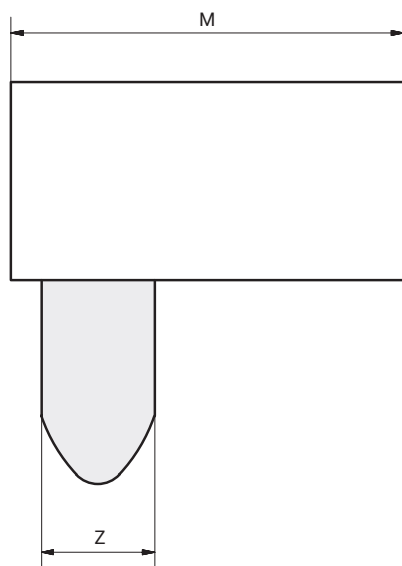

CODICE CODE	M	P MIN	H MIN	Z	E
411/78.1182.02	1200	450	90	350	620

Valori espressi in millimetri. Value expressed in millimetres.

Legenda tabella a pagina 112. Table key on page 112.





# Basket

SACCO LAVANDERIA CON PIANO ESTRAIBILE  
PULL-OUT LAUNDRY BAG WITH TOP

## DESIGN

Arch. Giulio Manzoni  
ATIM R&S / ATIM R&D

### FINITURA FINISHING

Inox bronzino

### PORTATA LOAD CAPACITY

40 Kg equamente distribuiti  
40 Kg evenly distributed

### PACKAGING

118x18x8 cm  
4 Kg  
0,017 m<sup>3</sup>

### SCORRIMENTO SLIDING

Alluminio / Alluminio  
Aluminium / Aluminium

### OPTIONAL

su richiesta on request

### KIT TAPPI KIT CAPS

2.9249311.XX

### CERNIERE HINGES

2.8016912.06

2.8029912.12

2.8048168.06

#### NOTE

L'articolo non prevede la fornitura delle parti in legno.  
L'articolo è fornito con sacco in tessuto.  
The item does not include the supply of wooden parts.  
The item supplied with fabric bag.

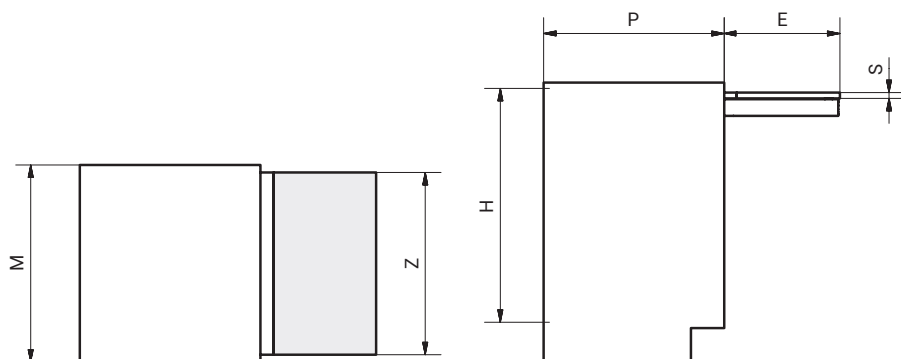

CODICE CODE	M	P MIN	H MIN	S1	E	Z	S MIN	SILENT
411/78.1183.25	450	450	690	15/20	350	405	16	78.1183.25
411/78.1184.25	600	450	690	15/20	350	555	16	78.1184.25
411/78.1185.25	900	450	690	15/20	350	855	16	78.1185.25

Valori espressi in millimetri. Value expressed in millimetres.

Legenda tabella a pagina 112. Table key on page 112.



# DIRECTORY

<b>M</b>	LARGHEZZA	WIDTH
<b>P</b>	PROFONDITÀ	DEPTH
<b>H</b>	ALTEZZA	HEIGHT
<b>S1</b>	SPESSORE SPALLA	SIDE THICKNESS
<b>E</b>	APERTURA PIANO	TOP OPENING
<b>Z</b>	LARGHEZZA PIANO	TOP WIDTH
<b>S</b>	SPESSORE PIANO	TOP THICKNESS
<b>ST</b>	SPESSORE TOP	COUNTERTOP THICKNESS
<b>T</b>	ALTEZZA MECCANISMO	HEIGHT MECHANISM
<b>L</b>	LARGHEZZA MECCANISMO	WIDTH MECHANISM

Le riproduzioni fotografiche sono puramente indicative e non danno luogo ad alcun vincolo contrattuale.  
L'azienda si riserva di modificare le caratteristiche dimensionali e tecniche dei prodotti in qualsiasi momento e senza l'obbligo di alcun preavviso.  
La riproduzione, anche parziale, è vietata a norma di legge.

The photographic reproductions are purely indicative and they do not contractual obligations.  
The company reserves the right in any time to modify technical notes and measures of the products, if necessary, without notice.  
All partial or total reproduction is strictly forbidden. All right reserved.

# Základní ceník výsuvných stolů Transformabili



Distributor: Alfa Styl, s.r.o., Cyriřká 14b, 602 00 Brno, Tel./Fax: 543 212 488, www.benevetti.cz, info@benevetti.cz

Tento ceník je platný od 1.11.2020

Model	Kód v katalogu	Základní cena bez DPH	Cena po slevě bez DPH EURO	Odkaz na video s fungováním výsuvu
<b>SIESTA</b>	411/78.1170.22	<b>7 986 Kč</b>	315,6 €	<a href="#">VIDEO</a>
pro šířku 450 - 1200 mm (úprava šířky uřezáním hliníkové tyče). Doporučujeme 2x překlápěcí pant V5341.				
<b>BRUNCH - 600 mm</b>	411/78.1100.22	<b>16 882 Kč</b>	667,3 €	<a href="#">VIDEO</a>
<b>BRUNCH - 900 mm</b>	411/78.1110.22	<b>16 882 Kč</b>	667,3 €	<a href="#">VIDEO</a>
<b>BRUNCH - 1200 mm</b>	411/78.1120.22	<b>16 882 Kč</b>	667,3 €	<a href="#">VIDEO</a>
<b>COCKTAIL</b>	411/78.1170.22 E	<b>5 916 Kč</b>	233,9 €	<a href="#">VIDEO</a>
pro šířku 450 - 1200 mm (úprava šířky uřezáním hliníkové tyče). Doporučujeme 2x překlápěcí pant V5341.				
<b>LUNCH</b>	411/78.1120.22 E	<b>7 069 Kč</b>	279,4 €	<a href="#">VIDEO</a>
pro šířku 450 - 1200 mm (úprava šířky uřezáním hliníkové tyče). Doporučujeme 2x překlápěcí pant V5341.				
<b>LUNCH REVERSE</b>	411/78.1130.25	<b>6 740 Kč</b>	266,4 €	<a href="#">VIDEO</a>
pro šířku 450 - 1200 mm. Doporučujeme 2x překlápěcí pant V5341.				
<b>SHOT</b>	411/78.1100.25 R	<b>4 604 Kč</b>	182,0 €	<a href="#">VIDEO</a>
pro šířku 450 - 1200 mm				
<b>DESK</b>	411/78.0005.02	<b>8 940 Kč</b>	353,4 €	<a href="#">VIDEO</a>
krytka mechanismu černá	2.5541204.10	<b>742 Kč</b>	29,3 €	<a href="#">VIDEO</a>
krytka mechanismu bílá	2.5541204.12	<b>742 Kč</b>	29,3 €	<a href="#">VIDEO</a>
<b>OPLA'</b>	411/78.1730.22	<b>7 922 Kč</b>	313,1 €	<a href="#">VIDEO</a>
pro šířku 450 - 1200 mm (úprava šířky uřezáním hliníkové tyče)				
<b>OPLA' FOLDING</b>	78.1720.25 F	<b>10 747 Kč</b>	424,8 €	<a href="#">VIDEO</a>
pro šířku 450 - 1200 mm (úprava šířky uřezáním hliníkových tyčí)				
<b>HOMEWORK</b>	411/78.1220.22	<b>9 327 Kč</b>	368,7 €	<a href="#">VIDEO</a>
pro šířku 450 - 1200 mm (úprava šířky uřezáním příčného profilu). Doporučujeme 4x barový pant A4103				
<b>COOK - 600 mm</b>	78.1490.25	<b>17 892 Kč</b>	707,2 €	
<b>COOK - 900 mm</b>	78.1491.25	<b>20 953 Kč</b>	828,2 €	
kompletní systém - výsuv + horní krájecí deska + dřevěná vložka na příbory + přídavná nádoba na odpadky				
<b>COOK - pouze výsuv</b>	78.COOK.T	<b>6 595 Kč</b>	260,7 €	
<b>FUNCTIONAL - 600 mm</b>	78.1493.25	<b>12 894 Kč</b>	509,6 €	<a href="#">VIDEO</a>
<b>FUNCTIONAL - 900 mm</b>	78.1494.25	<b>14 916 Kč</b>	589,6 €	<a href="#">VIDEO</a>
kompletní systém - výsuv + horní krájecí deska + dřevěná vložka na příbory				
<b>pouze výsuv - 600 mm</b>	78.1493.T	<b>5 107 Kč</b>	201,9 €	
<b>pouze výsuv - 900 mm</b>	78.1494.T	<b>5 107 Kč</b>	201,9 €	
<b>BASKET K - 450 mm</b>	78.1497.T	<b>5 585 Kč</b>	220,7 €	
<b>BASKET K - 600 mm</b>	78.1498.T	<b>5 655 Kč</b>	223,5 €	
<b>ZIP - 450 mm</b>	411/78.1260.22	<b>20 854 Kč</b>	824,3 €	
<b>ZIP - 600 mm</b>	411/78.1261.22	<b>20 854 Kč</b>	824,3 €	
<b>ZIP - 900 mm</b>	411/78.1262.22	<b>20 854 Kč</b>	824,3 €	
<b>READY - 450 mm</b>	411/78.1140.25	<b>12 420 Kč</b>	490,9 €	
<b>READY - 600 mm</b>	411/78.1141.25	<b>12 420 Kč</b>	490,9 €	
<b>READY - 900 mm</b>	411/78.1142.25	<b>12 420 Kč</b>	490,9 €	
<b>T-ABLE - 600 mm</b>	411/78.1900.22	<b>11 916 Kč</b>	471,0 €	<a href="#">VIDEO</a>
<b>T-ABLE - 900 mm</b>	411/78.1910.22	<b>11 916 Kč</b>	471,0 €	<a href="#">VIDEO</a>
<b>T-ABLE - 1200 mm</b>	411/78.1920.22	<b>11 916 Kč</b>	471,0 €	<a href="#">VIDEO</a>
doporučujeme 2-3x překlápěcí pant V5341				
<b>T-ABLE XL - 600 mm</b>	411/78.1900.22X	<b>13 774 Kč</b>	544,4 €	<a href="#">VIDEO</a>
<b>T-ABLE XL - 900 mm</b>	411/78.1910.22X	<b>13 774 Kč</b>	544,4 €	<a href="#">VIDEO</a>
<b>T-ABLE XL - 1200 mm</b>	411/78.1920.22X	<b>13 774 Kč</b>	544,4 €	<a href="#">VIDEO</a>
doporučujeme 4-6x překlápěcí pant V5341				
<b>JUST</b>	411/78.1990.25	<b>4 581 Kč</b>	181,1 €	
<b>JUST s pístem</b>	411/78.1990.25 P	<b>6 026 Kč</b>	238,2 €	

# Základní ceník výsuvných stolů Transformabili



Distributor: Alfa Styl, s.r.o., Cyriilská 14b, 602 00 Brno, Tel./Fax: 543 212 488, www.benevetti.cz, info@benevetti.cz

Tento ceník je platný od 1.11.2020

Model	Kód v katalogu	Základní cena bez DPH	Cena po slevě bez DPH EURO	Odkaz na video s fungováním výsuvu
T-BENCH - 450 mm	411/78.1950.22	10 697 Kč	422,8 €	<a href="#">VIDEO</a>
T-BENCH - 600 mm	411/78.1960.22	10 697 Kč	422,8 €	<a href="#">VIDEO</a>
doporučujeme 2x překlápěcí pant V5341				
T-BENCH XL - 600 mm	411/78.1960.22X	13 300 Kč	525,7 €	<a href="#">VIDEO</a>
doporučujeme 4x překlápěcí pant V5341				
PARTY - 600 mm	411/78.1500.22	22 607 Kč	893,6 €	<a href="#">VIDEO</a>
PARTY - 900 mm	411/78.1510.22	22 607 Kč	893,6 €	<a href="#">VIDEO</a>
PARTY - 1200 m	411/78.1520.22	22 607 Kč	893,6 €	<a href="#">VIDEO</a>
doporučujeme 4-6x překlápěcí pant V5341				
PARTY MENSOLA - 600 mm	411/78.1601.22	25 606 Kč	1 012,1 €	<a href="#">VIDEO</a>
PARTY MENSOLA - 900 mm	411/78.1602.22	25 606 Kč	1 012,1 €	<a href="#">VIDEO</a>
PARTY MENSOLA - 1200 m	411/78.1600.22	25 606 Kč	1 012,1 €	<a href="#">VIDEO</a>
EVOLUTION - 600 mm	411/78.1610.22	15 079 Kč	596,0 €	<a href="#">VIDEO</a>
EVOLUTION - 900 mm	411/78.1611.22	15 079 Kč	596,0 €	<a href="#">VIDEO</a>
EVOLUTION - 1200 m	411/78.1612.22	15 079 Kč	596,0 €	<a href="#">VIDEO</a>
doporučujeme 2-3x překlápěcí pant V5341				
EVOLUTION XL - 600 mm	411/78.1620.22	17 850 Kč	705,5 €	<a href="#">VIDEO</a>
EVOLUTION XL - 900 mm	411/78.1621.22	17 850 Kč	705,5 €	<a href="#">VIDEO</a>
EVOLUTION XL - 1200 m	411/78.1622.22	17 850 Kč	705,5 €	<a href="#">VIDEO</a>
doporučujeme 4-6x překlápěcí pant V5341				
OPLA' TOP	411/78.1780.22	7 922 Kč	313,1 €	<a href="#">VIDEO</a>
pro šířku 450 - 1200 mm (úprava šířky uřezáním hliníkové tyče)				
SANDWICH - 590 mm	411/78.1850.22	11 357 Kč	448,9 €	<a href="#">VIDEO</a>
SANDWICH - 800 mm	411/78.1860.22	11 357 Kč	448,9 €	<a href="#">VIDEO</a>
SANDWICH - 1100 mm	411/78.1870.22	11 357 Kč	448,9 €	<a href="#">VIDEO</a>
doporučujeme 2x překlápěcí pant V5341				
FLIP TOP - 450 mm	411/78.1800.22	7 442 Kč	294,2 €	<a href="#">VIDEO</a>
FLIP TOP - 600 mm	411/78.1810.22	7 442 Kč	294,2 €	<a href="#">VIDEO</a>
FLIP TOP - 900 mm	411/78.1820.22	7 442 Kč	294,2 €	<a href="#">VIDEO</a>
FLIP TOP - 1200 m	411/78.1830.22	7 442 Kč	294,2 €	<a href="#">VIDEO</a>
BREAKFAST - 600 mm	411/78.1251.22	27 756 Kč	1 097,1 €	<a href="#">VIDEO</a>
BREAKFAST Electric	411/78.1251.22 SM	111 209 Kč	4 395,6 €	<a href="#">VIDEO</a>
BREAKFAST TOP - 1200 mm	411/78.1252.22	27 756 Kč	1 097,1 €	<a href="#">VIDEO</a>
BREAKFAST TOP - 1800 mm	411/78.1253.22	27 756 Kč	1 097,1 €	<a href="#">VIDEO</a>
BREAKFAST TOP - 2400 mm	411/78.1254.22	27 756 Kč	1 097,1 €	<a href="#">VIDEO</a>
BREAKFAST TOP - 3000 mm	411/78.1255.22	27 756 Kč	1 097,1 €	<a href="#">VIDEO</a>
BREAKFAST TOP Electric	411/78.XXXX.SM	110 859 Kč	4 381,8 €	
SLIDE QUADRATO - 1200 mm	411/78.1241.22	19 146 Kč	756,8 €	<a href="#">VIDEO</a>
SLIDE RETTANGOLARE DX	411/78.1242.22	19 146 Kč	756,8 €	<a href="#">VIDEO</a>
SLIDE RETTANGOLARE SX	411/78.1243.22	19 146 Kč	756,8 €	<a href="#">VIDEO</a>
SLIDE QUADRATO - 900 mm	411/78.1245.22	19 146 Kč	756,8 €	<a href="#">VIDEO</a>
SNACK - 2500 mm	411/78.1281.22	14 276 Kč	564,3 €	<a href="#">VIDEO</a>
SNACK - 1900 mm	411/78.1282.22	14 276 Kč	564,3 €	<a href="#">VIDEO</a>
SNACK Electric - 2500 mm	411/78.1281 SM	111 987 Kč	4 426,4 €	<a href="#">VIDEO</a>
SNACK Electric - 1900 mm	411/78.1282 SM	111 987 Kč	4 426,4 €	<a href="#">VIDEO</a>
SNACK TOP - 900 mm	411/78.1283.22	14 774 Kč	584,0 €	<a href="#">VIDEO</a>
SNACK TOP - 1200 mm	411/78.1284.22	17 143 Kč	677,6 €	<a href="#">VIDEO</a>
SNACK TOP soft close - 900 mm	411/78.1283.22 A	16 824 Kč	665,0 €	<a href="#">VIDEO</a>
SNACK TOP soft close - 1200 mm	411/78.1284.22 A	19 193 Kč	758,6 €	<a href="#">VIDEO</a>
FLAP	411/78.1244.22	18 760 Kč	741,5 €	<a href="#">VIDEO</a>

# Základní ceník výsuvných stolů Transformabili



Distributor: Alfa Styl, s.r.o., Cyriilská 14b, 602 00 Brno, Tel./Fax: 543 212 488, www.benevetti.cz, info@benevetti.cz

Tento ceník je platný od 1.11.2020

Model	Kód v katalogu	Základní cena bez DPH	Cena po slevě bez DPH EURO	Odkaz na video s fungováním výsuvu
CORNER - 1200 mm	78.1230.25	13 635 Kč	538,9 €	<a href="#">VIDEO</a>
CORNER Right - 1200x900 mm	78.1231.25	13 635 Kč	538,9 €	<a href="#">VIDEO</a>
CORNER Left - 1200x900 mm	78.1232.25	13 635 Kč	538,9 €	<a href="#">VIDEO</a>
CORNER - 900 mm	78.1233.25	13 635 Kč	538,9 €	<a href="#">VIDEO</a>
CORNER Right - 900x600 mm	78.1234.25	13 635 Kč	538,9 €	<a href="#">VIDEO</a>
CORNER Left - 900x600 mm	78.1235.25	13 635 Kč	538,9 €	<a href="#">VIDEO</a>
TWICE	78.1480.T	13 643 Kč	539,3 €	
TWICE TOP	411/78.1470.25	15 941 Kč	630,1 €	
TOP 33 - 900 mm	411/78.1270.22	22 056 Kč	871,8 €	
TOP 33 - 1200 mm	411/78.1271.22	22 056 Kč	871,8 €	
VOILA - 900 mm	411/78.1190.25	23 020 Kč	909,9 €	<a href="#">VIDEO</a>
VOILA - 800 mm	411/78.1194.25	22 817 Kč	901,9 €	<a href="#">VIDEO</a>
VOILA - 955 mm	411/78.1195.25	22 817 Kč	901,9 €	<a href="#">VIDEO</a>
VOILA CHAIR - 800x700 mm	411/78.1330.25	25 670 Kč	1 014,6 €	<a href="#">VIDEO</a>
VOILA CHAIR - 900x700 mm	411/78.1331.25	25 670 Kč	1 014,6 €	<a href="#">VIDEO</a>
VOILA CHAIR - 1000x700 mm	411/78.1332.25	25 670 Kč	1 014,6 €	<a href="#">VIDEO</a>
VOILA CHAIR - 800x800 mm	411/78.1333.25	25 670 Kč	1 014,6 €	<a href="#">VIDEO</a>
VOILA CHAIR - 900x800 mm	411/78.1334.25	25 670 Kč	1 014,6 €	<a href="#">VIDEO</a>
VOILA CHAIR - 1000x800 mm	411/78.1335.25	25 670 Kč	1 014,6 €	<a href="#">VIDEO</a>
VOILA CHAIR - 800x900 mm	411/78.1336.25	25 670 Kč	1 014,6 €	<a href="#">VIDEO</a>
VOILA CHAIR - 900x900 mm	411/78.1337.25	25 670 Kč	1 014,6 €	<a href="#">VIDEO</a>
VOILA CHAIR - 1000x900 mm	411/78.1338.25	25 670 Kč	1 014,6 €	<a href="#">VIDEO</a>
VOILA CHAIR REV - 1100x700 mm	411/78.1320.25	26 501 Kč	1 047,5 €	<a href="#">VIDEO</a>
VOILA CHAIR REV - 1300x700 mm	411/78.1321.25	26 501 Kč	1 047,5 €	<a href="#">VIDEO</a>
VOILA CHAIR REV - 1100x800 mm	411/78.1322.25	26 501 Kč	1 047,5 €	<a href="#">VIDEO</a>
VOILA CHAIR REV - 1300x800 mm	411/78.1323.25	26 501 Kč	1 047,5 €	<a href="#">VIDEO</a>
VOILA CHAIR REV - 1100x900 mm	411/78.1324.25	26 501 Kč	1 047,5 €	<a href="#">VIDEO</a>
VOILA CHAIR REV - 1300x900 mm	411/78.1325.25	26 501 Kč	1 047,5 €	<a href="#">VIDEO</a>
DINAMICO+ table 20	78.1192.25	34 370 Kč	1 358,5 €	<a href="#">VIDEO</a>
DINAMICO+ table 40	78.1193.25	34 370 Kč	1 358,5 €	<a href="#">VIDEO</a>
DINAMICO pouze vysuv	411/78.1301.25	11 551 Kč	456,6 €	<a href="#">VIDEO</a>
SESTANTE Univerzal	411/78.129X.22	24 883 Kč	983,5 €	<a href="#">VIDEO</a>
<b>Mechanismy na hloubku 390 mm</b>				
EVOLUTION +39 - 600 mm	411/39.1610.25	15 215 Kč	601,4 €	<a href="#">VIDEO</a>
EVOLUTION +39 - 900 mm	411/39.1611.25	15 215 Kč	601,4 €	<a href="#">VIDEO</a>
EVOLUTION +39 - 1200 mm	411/39.1612.25	15 215 Kč	601,4 €	<a href="#">VIDEO</a>
doporučujeme 2-3x překlápěcí pant V5341				
EVOLUTION XL +39 - 600 mm	411/39.1620.25	17 850 Kč	705,5 €	<a href="#">VIDEO</a>
EVOLUTION XL +39 - 900 mm	411/39.1621.25	17 850 Kč	705,5 €	<a href="#">VIDEO</a>
EVOLUTION XL +39 - 1200 mm	411/39.1622.25	17 850 Kč	705,5 €	<a href="#">VIDEO</a>
doporučujeme 4-6x překlápěcí pant V5341				
HOMEWORK +39	411/39.1220.25	8 310 Kč	328,5 €	<a href="#">VIDEO</a>
pro šířku 450 - 1200 mm (úprava šířky uřezáním příčného profilu). Doporučujeme 4x barový pant A4103				
LUNCH +39	411/39.1100.25	6 822 Kč	269,6 €	<a href="#">VIDEO</a>
pro šířku 450 - 1200 mm (úprava šířky uřezáním hliníkové tyče). Doporučujeme 2x překlápěcí pant V5341.				
MENSOLA T-ABLE +39	411/39.1920.25X	13 910 Kč	549,8 €	<a href="#">VIDEO</a>
OPLA' +39	411/39.1700.25	7 922 Kč	313,1 €	<a href="#">VIDEO</a>
OPLA' +39	411/39.1720.25	7 922 Kč	313,1 €	<a href="#">VIDEO</a>
OPLA' FOLDING +39	411/39.1700.25 F	9 111 Kč	360,1 €	<a href="#">VIDEO</a>
OPLA' FOLDING +39	411/39.1720.25 F	9 111 Kč	360,1 €	<a href="#">VIDEO</a>

# Základní ceník výsuvných stolů Transformabili



Distributor: Alfa Styl, s.r.o., Cyrilská 14b, 602 00 Brno, Tel./Fax: 543 212 488, www.benevetti.cz, info@benevetti.cz

*Tento ceník je platný od 1.11.2020*

Model	Kód v katalogu	Základní cena bez DPH	Cena po slevě bez DPH EURO	Odkaz na video s fungováním výsuvu
T-BENCH +39	411/39.1950.22	10 382 Kč	410,3 €	<a href="#">VIDEO</a>
T-BENCH +39	411/39.1960.22	10 382 Kč	410,3 €	<a href="#">VIDEO</a>
doporučujeme 2x překlápěcí pant V5341				
SHOT +39	411/39.1130.25	4 155 Kč	164,2 €	
<b>Ostatní mechanismy</b>				
PRUA	411/78.1180.22	10 696 Kč	422,8 €	<a href="#">VIDEO</a>
PRUA SHORT	411/78.1181.22	10 696 Kč	422,8 €	<a href="#">VIDEO</a>
PRUA LIFT - 350 mm	411/78.1180.22	4 909 Kč	194,1 €	<a href="#">VIDEO</a>
PRUA LIFT - 450 mm	411/78.1181.22	4 909 Kč	194,1 €	<a href="#">VIDEO</a>
PRUA SWING	411/78.1182.22	5 111 Kč	202,0 €	
BASKET - 450 mm	78.1183.25	5 720 Kč	226,1 €	
BASKET - 600 mm	78.1184.25	5 791 Kč	228,9 €	
BASKET - 900 mm	78.1185.25	5 968 Kč	235,9 €	
BASKET - 1200 mm	78.1186.25	5 968 Kč	235,9 €	
doporučujeme 2-3x překlápěcí pant V5341				
<b>Doplňkové kování</b>				
překlápěcí pant VICI	V4341002	86 Kč	3,4 €	
barový pant	A4103024	79 Kč	3,1 €	

Poznámka:

pant V4341



pant A4103



V ceně výsuvných stolů je rozkládací mechanismus + veškeré komponenty pro jeho montáž. Součástí ceny **není** stolová deska ani skříňka pokud není uvedeno jinak. Panty nejsou součástí ceny, možno dokoupit spolu s výsuvem. Na požádání Vám vypracujeme cenovou nabídku na dodávku výsuvu včetně stolových desek..

**Téměř všechny mechanismy je možno rozměrově upravit s příplatkem +15%.**

**Zeleně označené položky držíme běžně skladem. Ostatní položky jsou na objednávku.**

Položky na objednávku jsou k dispozici do 3-5 týdnů.